

**LUDLUM MODEL 177-84
ALPHA/BETA RATEMETER**

**September 2023
Serial No. 128600 and Succeeding
Serial Numbers**

**LUDLUM MODEL 177-84
ALPHA/BETA RATEMETER**

**September 2023
Serial No. 128600 and Succeeding
Serial Numbers**



LUDLUM MEASUREMENTS, INC
501 OAK STREET, P.O. BOX 810
SWEETWATER, TEXAS 79556
325-235-5494, FAX: 325-235-4672

STATEMENT OF WARRANTY

Ludlum Measurements, Inc. warrants the products covered in this manual to be free of defects due to workmanship, material, and design for a period of twelve months from the date of delivery. The calibration of a product is warranted to be within its specified accuracy limits at the time of shipment. In the event of instrument failure, notify Ludlum Measurements to determine if repair, recalibration, or replacement is required.

This warranty excludes the replacement of photomultiplier tubes, G-M and proportional tubes, and scintillation crystals which are broken due to excessive physical abuse or used for purposes other than intended.

There are no warranties, express or implied, including without limitation any implied warranty of merchantability or fitness, which extend beyond the description of the face there of. If the product does not perform as warranted herein, purchaser's sole remedy shall be repair or replacement, at the option of Ludlum Measurements. In no event will Ludlum Measurements be liable for damages, lost revenue, lost wages, or any other incidental or consequential damages, arising from the purchase, use, or inability to use product.

RETURN OF GOODS TO MANUFACTURER

If equipment needs to be returned to Ludlum Measurements, Inc. for repair or calibration, please send to the address below. All shipments should include documentation containing return shipping address, customer name, telephone number, description of service requested, and all other necessary information. Your cooperation will expedite the return of your equipment.

**LUDLUM MEASUREMENTS, INC.
ATTN: REPAIR DEPARTMENT
501 OAK STREET
SWEETWATER, TX 79556**

**800-622-0828 325-235-5494
FAX 325-235-4672**



LUDLUM
MEASUREMENTS
SWEETWATER, TX

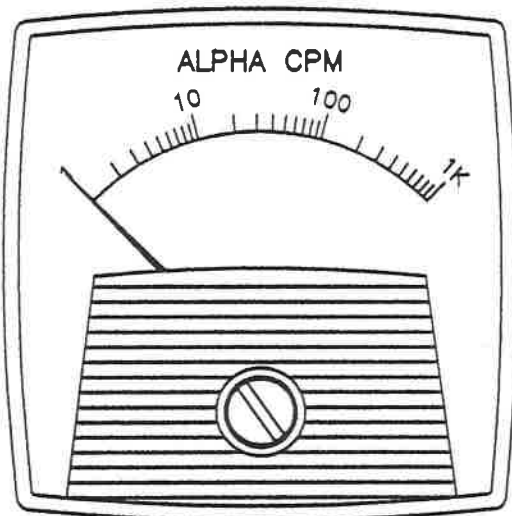

LUDLUM
MEASUREMENTS
SWEETWATER, TX

- STATUS
- UPDATING BKGND
 - CHECKING
 - CHECK OK
 - INCOMPLETE
 - OVERLOAD
 - LOW BATTERY

ALPHA
ALARM

ACK / RESET



BETA
ALARM

METER MODE

- RATEMETER
- READ ALARM
- READ HV

MODEL 177-84
ALPHA - BETA FRISKER

CHG	NO.				BY	CHK	APP
DATE		CHK	DATE	APP	DATE		
GW	12-9-95			GW	5-29-07		
TOL:	SHIP STD <input type="checkbox"/>	OTHER	SCALE:	FULL <input type="checkbox"/>	OTHER		
TITLE M 177-84 FRONT VIEW							
LUDLUM MEASUREMENTS INC. 801 ONE STREET SWEETWATER, TEXAS 75086				SERIES	SHEET		
				347	253		

XXXXXX

POWER

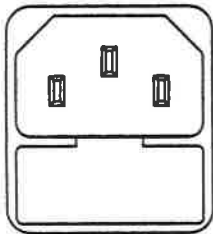
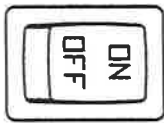

INPUT: 115 VAC
50/60 Hz 50 W

LINE FUSE
LITTELFUSE F 1A



COUNT SWITCH

DETECTOR

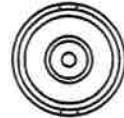

BATTERY ACCESS DOOR
BATTERY SHOULD BE
REPLACED AT LEAST
EVERY 4 YEARS

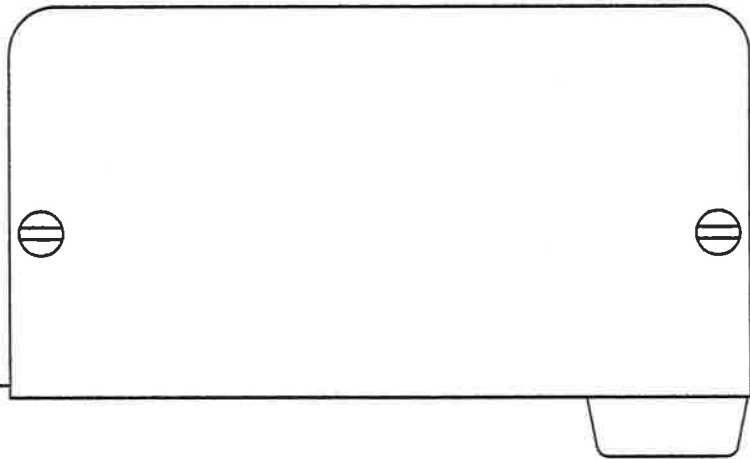

CHG	NO.					DWN	CHK	APP
DWN	DATE	CHK	DATE	APP	DATE			
GW	12-9-95			J6w	5-29-07			
TOL:	SHIP STD <input type="checkbox"/>	OTHER	SCALE:	FULL <input type="checkbox"/>	OTHER			
TITLE M 177-84 REAR VIEW								
LUDLUM MEASUREMENTS, INC. 501 DMK STREET EVERETT, TEXAS 75536			SERIES	347		SHEET 254		

Table of Contents

1. INTRODUCTION	1
2. SPECIFICATIONS	3
3. DESCRIPTION OF CONTROLS AND FUNCTIONS	5
FRONT PANEL.....	5
REAR PANEL	6
INTERNAL CONTROLS	6
4. SAFETY CONSIDERATIONS AND MAINTENANCE.....	9
ENVIRONMENTAL CONDITIONS FOR NORMAL USE	9
CLEANING INSTRUCTIONS AND PRECAUTIONS	9
REPLACEMENT OF FUSES	10
MAINTENANCE	10
INSTRUMENT RETURN FOR REPAIR/CALIBRATION	10
BATTERY REPLACEMENT	11
ELECTRICAL SAFETY PRECAUTIONS	11
5. OPERATING PROCEDURES	12
THEORY OF OPERATION	13
DETECTOR INPUT/AMPLIFIER	13
ALPHA/ BETA DISCRIMINATOR.....	13
ALPHA/BETA DISCRIMINATOR LOGIC CIRCUIT	14
LOW VOLTAGE SUPPLY	14
HIGH VOLTAGE SUPPLY	14
DETECTOR OVERLOAD.....	14
METER DRIVE.....	15
MICROPROCESSOR.....	15
AUDIO	15
6. RECYCLING.....	16
7. PARTS LIST.....	17
MAIN BOARD (DRAWING 347 X 600).....	17
FRONT PANEL BOARD (DRAWING 347 X 244)	20
CHASSIS WIRING DIAGRAM (DRAWING 347 X 243).....	21
8. APPENDIX.....	23
APPENDIX 1 – CHECKOUT PROCEDURE.....	23
APPENDIX 2 – MODEL 177-84 MODE SWITCH ADDITION	25
APPENDIX 3 – MODEL 4902 SPECIFICATIONS	26
9. DRAWINGS AND DIAGRAMS	27

Section

1

Introduction

The Model 177-84 is a microprocessor-based radiation survey instrument used to measure and discriminate low-level alpha/beta radiation when used with an alpha/beta scintillation or proportional detector. The instrument has beta automatic background subtract and beta automatic background update. It also has an adjustable count timer, which can be set from 0 to 120 seconds. An external switch must be connected to the instrument to initiate a count.



The radiation level is displayed on two analog meters. The Alpha meter dial indicates 0-1000 cpm on a three-decade log scale. The Beta meter dial indicates 0-100,000 cpm on a three-decade log scale. Each channel has its own distinguishable click-per-event audible tone. Beta events are a low pitch and alpha events are a high pitch. Beta clicks-per-event can be set at 1 per 1, 10, 100, or 1000.

Each channel has its own alarm point, which is adjustable from 0 to full scale. Alarms are indicated by an audible tone and LEDs (Light Emitting Diodes) located underneath the meters.

A regulated high-voltage power supply adjustable from 200 to 2000 volts with detector overload detection is utilized to operate a wide range of scintillation detectors. Other operating features of the instrument include

Model 177-84 Alpha/Beta Ratemeter

adjustable volume, low-battery LED, high-voltage readout, alarm audio acknowledge, and meter reset.

All calibration controls are located internally to prevent tampering. The only user accessible controls include the Acknowledge/Reset push-button switch, a rotary switch to switch the meters between ratemeter readout, alarm setpoint readout, high voltage readout, and the ON/OFF switch located on the rear of the instrument.

Count times are adjustable from zero to 120 seconds in 8-second increments. Setting count time to zero puts the instrument into a continuous counting mode and it will continue to count as long as the count switch is closed.

The unit operates on line power or an internal rechargeable battery. It is useable in temperatures ranging from -15 to approximately 50 °C (5 to 122 °F).

Section

2

Specifications

HIGH VOLTAGE: variable from 200 to 2500 volts

ALPHA THRESHOLD: adjustable from -4 to -180 mV

ALPHA METER SCALE: 0-1000 cpm

BETA THRESHOLD: adjustable from -1 through -4 mV

BETA WINDOW: adjustable from 4 to 70 mV

BETA METER SCALE: 0-100,000 CPM; 0-2.0 kV

CROSSTALK: no more than 1% of gross alpha counts in beta channel and no more than 10% of gross counts in alpha channel

LINEARITY: within 10% of true value, typically plus or minus 2% of true value when measured with an electronic pulser

RESPONSE TIME: The microprocessor calculates the response time based on the number of incoming counts. The Beta time constant varies between 1 and 5 seconds, and the Alpha varies between 5 and 15 seconds.

METERS: 1 mA, 2.5 in DC movement.

COUNT TIME: adjustable from 0 to 120 seconds, in 8-second increments

COUNT SWITCH CONNECTOR: phone jack TINI-JAX #41

CONNECTOR: Series "C" (other connectors available)

AUDIO: Dual tone click-per-event through a built-in unimorph with an internal volume control and internally switchable divide by of 1, 10, 100, and 1000 counts per click (beta only).

ALARM RANGE: adjustable from 0 through full scale

FINISH: powder coat paint

Model 177-84 Alpha/Beta Ratemeter

FUSE: 1 amp, 5 x 20 mm 250 V fuse

POWER: 117 VAC 60 Hz line power and internal rechargeable 6 V (sealed lead-acid) battery; battery life approximately 50 hours

BATTERY DEPENDANCE: instrument calibration change less than 3% until Low Battery LED comes on

SIZE: 19.1 x 22.9 x 15.3 cm (7.5 x 9 x 6 in.) (H x W x L), excluding handle

WEIGHT: 2.3 kg (4.9 lb)

Section

3

Description of Controls and Functions

Front Panel

METERS: The left meter is a three-decade log scale that shows the number of alpha counts. The right meter is a three-decade log scale that shows the number of beta counts.

STATUS LEDs: six small LEDs that indicate the status of the instrument.

UPDATING BACKGROUND: When this LED is lit, the instrument is updating the background values it will use when subtracting background from a count. Also, when this LED is lit, the instrument is ready for use. When the instrument is first turned on, it will take a mandatory 20-second background count. While it is taking this count, the UPDATING BACKGROUND LED will be flashing.

CHECKING: When this LED is lit, the instrument is taking a count. This LED will stay on until the count time has expired or until the switch is opened when count time is set to zero.

CHECK OK: This LED will come on after a count has been completed. It will not operate when the count time is set to zero.

INCOMPLETE: This LED will come on if the count switch is opened before the count time has expired. It will stay on for 4 seconds or until the switch is closed.

OVERLOAD: This LED will come on to indicate that the detector is saturated either by a puncture in the detector face on a scintillation detector, or an exposure to a radiation field above the counting capability of the instrument. The analog meters will deflect full scale when the OVERLOAD LED is illuminated.

LOW BATTERY: This LED will come on when the charge on the battery has dropped below the useable range. The voltage level is 5.5 volts measured at the battery terminals.

Model 177-84 Alpha/Beta Ratemeter

ALPHA ALARM: This LED will come on when the alpha radiation level has exceeded the alpha alarm point.

BETA ALARM: This LED will come on when the beta radiation level has exceeded the beta alarm point.

ACK/RESET: This pushbutton has two functions. If the instrument is in an alarm condition, the first push of the button will turn the audio off. The second push will reset the meters to zero. If there is no alarm, the first push will reset the meters to zero.

METER MODE: The METER MODE switch has three functions. In the RATEMETER position, the meters will show incoming counts. In the READ ALARM position, the meters will indicate the alarm setpoints. In the READ HV position, the dual scale beta meter will show the HV setpoint on the kV scale. The alpha meter will go to zero.

Rear Panel

POWER: This switch turns the instrument ON and OFF.

INPUT - LINE FUSE: This is the connector that the cord plugs into to provide power to the instrument. The line fuse is the main fuse for the instrument. To change the fuse, remove the power cord and pry the fuse section out with a screwdriver.

BATTERY ACCESS DOOR: The internal rechargeable battery can be accessed by removing this door. The battery should be replaced at least every 4 years. The red wire plugs onto the positive terminal of the battery.

COUNT SWITCH: This is a TINI-JAK #41 phone jack. Connect the mating connector to a normally open switch. The switch can then be used to start counts.

DETECTOR: This is a coax connector used to connect the instrument to the detector.

Internal Controls

Remove the instrument cover to access the following controls.

AT - Alpha Threshold: This control sets the threshold level for the Alpha channel. It is adjustable from -1 to -180 mV.

AAP - Alpha Alarm Point: This control sets the Alpha alarm point. Turn the METER MODE switch to READ ALARM in order to view and set the alarm point. The alarm point can be set from zero to full scale.

AMC - Alpha Meter Cal: This control calibrates the Alpha meter.

Model 177-84 Alpha/Beta Ratemeter

BT - Beta Threshold: This control sets the threshold level for the Beta channel. It is adjustable from -1 to -4 mV.

BAP - Beta Alarm Point: This control sets the Beta alarm point. Turn the METER MODE switch to READ ALARM to view and set the alarm point. The alarm point can be set from zero to full scale.

BMC - Beta Meter Cal: This control calibrates the Beta meter.

BW - Beta Window: This control sets the Beta window level. It is adjustable from 4 to 70 mV.

HVR - High Voltage Readout: This control calibrates the high-voltage (kV) scale on the Beta meter. Turn the Meter Mode switch to READ HV to view and calibrate the high voltage readout.

HVL - High Voltage Limit: This control sets the maximum allowable high-voltage setting. The maximum setting is approximately 2.2 kV. The maximum reading on the meter dial is 2.0 kV.

HVS - High Voltage Setpoint: This control sets the high voltage. Turn the METER MODE switch to READ HV to view and set the high-voltage setpoint.

OL - Overload: This control sets the high-voltage current level at which the overload circuit will be triggered.

BAT - Battery: This control sets the charge voltage for the battery. This point is typically 6.9 volts measured at the battery terminals.

VOL - Volume: This control sets the audio volume. Clicks as well as alarm tones are adjusted by this control.

Four-position DIP Switch: Positions 1 and 2 control the audio divide for Beta clicks. Settings and values are listed below:

	Pos 1	Pos 2
1	On	On
10	Off	On
100	On	Off
1000	Off	Off

Example: For a setting of 1000, the instrument will give one click for every 1000 counts it registers.

Note: The AUDIO divide function only affects the lower frequency beta tones. The higher frequency clicks-per-events will be unaffected by the

Model 177-84 Alpha/Beta Ratemeter

divide-by selection.

Position 3: This position puts the instrument into meter calibration mode. When the third switch is turned on, the meters will be driven to full scale. You can then use the meter cal controls (AMC and BMC) to adjust the meters to read full scale.

Position 4: This position selects whether the alarms are latching or non-latching. When this switch is on, the alarms are latching. When it is set to latching, the alarm will stay on for 4 seconds after the count time is expired. When in non-latching, the alarm will go off as soon as the radiation level goes back below the alarm point.

16 Position Rotary Switch: This control sets the duration of the counting period in multiples of 8 seconds. When set to zero, the instrument will continue to count as long as the count switch is closed. The duration of the counting period for different settings is listed below:

Setting	Duration
0	until switch opened
1	8 seconds
2	16 seconds
3	24 seconds
4	32 seconds
.	
.	
.	
E	112 seconds
F	120 seconds

Section

4

Safety Considerations and Maintenance

Environmental Conditions for Normal Use

Indoor use only

No maximum altitude

Temperature range of -20 to 50 °C (-4 to 122 °F)

Maximum relative humidity of less than 95% (non-condensing)

Mains supply voltage range 95-250 Vac

Maximum transient voltage of 1500 Vac

Installation Category (Overvoltage Category) II (as defined by IEC 1010-1)

Pollution Degree 2 (as defined by IEC 644) (Normally only nonconductive pollution occurs. Temporary conductivity caused by condensation is to be expected.)

Cleaning Instructions and Precautions

The Model 177-84 may be cleaned externally with a damp cloth, using only water as the wetting agent. Do not immerse the instrument in any liquid. In addition, the operator is strongly cautioned to avoid contact with internal hazardous live parts that are accessible using a tool. Observe the following precautions when cleaning

1. Turn the instrument OFF and disconnect the instrument power cord.
2. Allow the instrument to sit for one minute before cleaning.

Caution!

Verify instrument voltage input rating before connecting to a power converter. If the wrong power converter is used, the instrument and/or power converter could be damaged.

Caution!

The operator or responsible body is cautioned that the protection provided by the equipment may be impaired if the equipment is used in a manner not specified by Ludlum Measurements, Inc.

Replacement of Fuses

Warning!

For continued protection against risk of fire, replace only with fuses of the specified type and current rating!

Maintenance

Instrument maintenance consists of keeping the instrument clean, replacing the battery when necessary, and periodically checking the calibration.

An instrument operational check should be performed at least daily by exposing the detector to a known source and confirming the proper reading on the instrument.

Re-calibration should be accomplished after any maintenance or adjustment of any kind has been performed on the instrument.

Ludlum Measurements recommends recalibration at intervals no greater than one year. Check the appropriate regulatory agencies' regulations to determine required recalibration intervals.

Instrument Return for Repair/Calibration

To return an instrument for repair or calibration, provide sufficient packing material to prevent damage during shipment.

Every returned instrument must be accompanied by an **Instrument Return**

Model 177-84 Alpha/Beta Ratemeter

Form, which can be downloaded from the Ludlum website at www.ludlums.com. Find the form by clicking the “Support” tab and selecting “Service Department” from the drop-down menu. Then choose the appropriate Service Department division where you will find a link to the form.

Battery Replacement

The battery should be replaced at least every four years. To replace the battery, remove the two screws holding the battery access door on the rear of the instrument and remove the door. Slide the battery out and unplug the wires from the terminals. Attach wires to the new battery (red wire goes to the positive terminal) and slide back into place. Replace the door.

Electrical Safety Precautions

Warning!

Ignoring the following warnings could result in a potentially hazardous situation, which if mishandled, could result in death or serious personal injury.

- Do not expose the unit to rain or an environment where it may be splashed by water or other liquids, as doing so may result in fire or electric shock.
- Use the unit only with the voltage specified of the unit. Using a voltage higher than that which is specified, may result in fire or electric shock.
- Do not cut, kink, or otherwise damage or modify the power supply cord. In addition, avoid using the power cord in proximity to a heater, and never place heavy objects – including the unit itself – on the power cord, as doing so may result in fire or electric shock.
- Avoid installing or mounting the unit or its power supply in unstable locations, such as on a rickety table or a slanted surface. Doing so may result in the unit falling down and causing personal injury or property damage.

Section

5

Operating Procedures

- Remove the cover of the Model 177-84 and set the alarm points, audio volume, beta audio divide, and the count time as desired. Replace the cover.
- Connect a detector to the Model 177-84.

The detector operating parameters are established by adjusting the detector operating voltage (HV), alpha threshold, and beta window to find an optimum efficiency for the alpha/beta scintillator or proportional detector.

The threshold and window parameters can be adjusted to optimize alpha/beta count discrimination, count efficiency, and minimize "cross talk" between channels. Refer to the specific detector Operation Manual or calibration certificate for the suggested threshold and window settings. Once the thresholds and window settings are established, an operating voltage-versus-count-rate plot should be performed for both alpha and beta count channels with alpha and beta particle emission sources.

The following procedure is an example of determining an operating voltage, threshold, and window settings for an alpha/beta scintillation or proportional detector:

- Connect a Ludlum Model 500 Pulser or equivalent to the Model 177-84.
- While the Model 177-84 is in the Updating Background mode, adjust the beta threshold (BT) for 2.0 mV and the window (BW) for 50 mV. The pulser counts should be detected on the beta meter above 2.0 ± 1 mV and should shut off above 50mV.
- Adjust the pulser for a 75 mV pulse output and vary the AT control until counts are detected on the alpha meter.
- Switch the Meter Mode switch to Read HV and adjust the HVS potentiometer for 0.4 to 0.5 kV on the 0-2.0 kV scale. Connect the detector to the instrument. Switch Meter Mode back to Ratemeter. Place an alpha source on the detector face.

Model 177-84 Alpha/Beta Ratemeter

- Slowly increase the HVS potentiometer to observe the beta meter for an increase, then decrease, and increase again in count as the HV is increased. Decrease the HV until the ratemeter is in the "dip" of the observed count rate-versus-HV plot just performed. Switch to Read HV and note the HV setting.
- Plot an HV-versus-count rate plateau in 25 volt increments, 50 volts each side of the HV reading found in the above step (i.e., HV setting for count "dip" in the above step = 675 volts; start the plot at 625 volts and increase in 25 volts steps until 725 volts is reached). Plot alpha source, beta source, and background counts for both the alpha and beta channels.
- Find the optimum operating voltage from the plot, which gives the greatest alpha and beta source efficiency while maintaining no greater than the maximum acceptable level of "cross talk" between channels.
- Proceed to use instrument.

Theory of Operation

Refer to schematic series 347, sheet 600 for the following:

Detector Input/Amplifier

Negative going detector pulses are coupled from the detector through C032 to Amplifier U031. R032 and CR031 protect the input of U031 from inadvertent shorts. Self-biased amplifier U031 provides gain in proportion to R031 divided by R032. Transistor pins 4, 5, and 6 of U031 provide amplification. Pins 12 and 15 of U031 are coupled as a constant current source to pin 6 of U031. The output self-biases to $2V_{be}$ (approximately 1.4 volts) at pin 7 of U031. This provides just enough bias current through pin 6 of U031 to conduct all of the current for the constant current source. Positive pulses from pin 7 of U031 are coupled to the discriminators through R021 and C021.

Alpha/Beta Discriminator

Positive pulses from amplifier U031 are coupled to comparator U022, pin 6, for alpha discrimination and pins 6 and 2 of U021 for beta discrimination. R001, Alpha Threshold, provides the reference voltage for alpha comparator U022. R103, Beta Threshold (defined as the lower threshold limit of the beta counting window) provides the reference voltage for beta threshold comparator pins 1, 2, and 3 of U021. R202, Beta Window (defined as the upper threshold limit of the beta counting window) provides the reference voltage for the beta window comparator pins 5, 6, and 7 of U021.

Alpha/Beta Discriminator Logic Circuit

Alpha pulses from U022 are coupled to univibrator U121. Pulses at pin 6 of U121 are inverted by Q121 for connection to reset (R) pins 3, 13 of U111. Pin 9 of U121 provides the pulses to be counted by the microprocessor (μ P). Pulses from pin 9 of U121 are connected to pin 3 of U121 to provide a time delay for the μ P clock cycle to complete before the next alpha pulse can be recognized by the μ P.

Beta pulses from pin 1 of U021 are coupled to univibrator U111. Pulses are coupled to the μ P from pin 7 of U111 as long as pins 3 and 13 of U111 remain high (+5V). When an alpha and/or a beta window pulse is present, the reset (pins 3 and 13 of U111) function is enabled and 7 of U111 remains high. Pin 7 of U111 is connected to pin 13 of U111 to provide a time delay for the μ P clock cycle to complete before the next beta pulse can be recognized by the μ P.

Low Voltage Supply

Supply Voltage is supplied by the linear regulator VR421 and associated components to provide +5V to power op-amps and logic circuitry. U011 and related components provide +2.5 V reference HVS and Alpha/Beta discriminator controls. U521 regulates the trickle charge to the battery.

High Voltage Supply

High voltage is developed by blocking oscillator Q431, T331, C422, and rectified by voltage multiplier CR231-CR235, C231-C233, C221, and C133. High voltage increases as current through Q431 increases, with maximum output voltage with Q431 saturated.

High voltage is coupled back through R321 to op-amp pin 2 of U321. Resistor network R302-303 completes the HV division circuit to ground. R302 provides HV limit at 2.0 kV when the HVS control is at maximum. The regulated HV output is controlled by HVS potentiometer R304. This control provides the reference for comparator pin 3, U321. During stable operation, the voltage at pin 2 of U321 will equal the voltage at pin 3 of U321. Pin 1 of U321 will cause conduction of Q321 to increase or decrease until the HV finds a level of stability. R204, HVR, calibrates the analog meter to the HV output when the METER MODE switch is in the READ HV position.

Detector Overload

A voltage drop is developed across R131 and sensed by comparator U022 as detector current increases. When the voltage at pin 3 of U022 goes below

Model 177-84 Alpha/Beta Ratemeter

pin 2, pin 1 goes low, illuminating the OVERLOAD LED and driving the meter to full scale. R305, OL, provide adjustment for the overload set point.

Meter Drive

Pulses are coupled to the gate of Q201 and Q301. R403 and C401 provides integration. Integrated meter drive voltage is coupled via the METER MODE switch to U212. The meter is driven by the emitter of Q211 and Q311, coupled as a voltage follower in conjunction with U212. R101 (AMC) and R201 (BMC) are adjusted to calibrate the ratemeter reading, corresponding to the incoming count rate. R312, R313, R215, and R216 provide temperature compensation for changes in the meter resistance due to temperature variations.

Microprocessor

U411, Intel N87C51FA, controls all of the data, control inputs, and display information. The clock frequency is crystal controlled by Y311 and related components at 6.144 MHz. The μ P incorporates internal memory (ROM), storing the program information. C423 resets the μ P at power-up to initiate the start of the program routine. During the program loop the μ P looks at all of the input switches for initiation or status changes and responds accordingly.

The μ P uses pulse-width modulation to control the analog ratemeter. The analog outputs, ALPHA RATE and BETA RATE, are divided into 255 increments in a 166 μ s period. At full meter deflection the low pulse period, leading edge to leading edge, will be 166 μ s, 500 cpm = 130 μ s, 400 cpm = 104 μ s, 200 cpm = 52 μ s, 100 cpm = 26 μ s, and 0 = no pulse or +5 V.

Audio

Alpha and/or beta audio pulse frequency is generated by the μ P and coupled to Q501. Q501 then inverts the pulses and drives the negative side of the speaker. Bias voltage is provided by the volume control, R402.

Section

6

Recycling

Ludlum Measurements, Inc. supports the recycling of the electronics products it produces for the purpose of protecting the environment and to comply with all regional, national, and international agencies that promote economically and environmentally sustainable recycling systems. To this end, Ludlum Measurements, Inc. strives to supply the consumer of its goods with information regarding reuse and recycling of the many different types of materials used in its products. With many different agencies – public and private – involved in this pursuit, it becomes evident that a myriad of methods can be used in the process of recycling. Therefore, Ludlum Measurements, Inc. does not suggest one particular method over another, but simply desires to inform its consumers of the range of recyclable materials present in its products, so that the user will have flexibility in following all local and federal laws.

The following types of recyclable materials are present in Ludlum Measurements, Inc. electronics products, and should be recycled separately. The list is not all-inclusive. Nor does it suggest that all materials are present in each piece of equipment:

- Batteries
- Glass
- Aluminum and Stainless Steel
- Circuit Boards
- Plastics
- Liquid Crystal Display (LCD)

Ludlum Measurements, Inc. products, which have been placed on the market after August 13, 2005, have been labeled with a symbol recognized internationally as the “crossed-out wheelie bin.” This notifies the consumer that the product is not to be mixed with unsorted municipal waste when discarding; each material must be separated. The symbol will be placed near the AC receptacle, except for portable equipment where it will be placed on the battery lid.



Model 177-84 Alpha/Beta Ratemeter

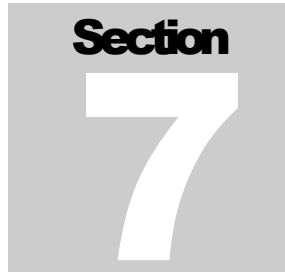

Parts List

	<u>Reference</u>	<u>Description</u>	<u>Part Number</u>
Model 177-84 Alpha/Beta Ratemeter	UNIT	Completely Assembled Model 177-84 Alpha/Beta Ratemeter	48-2727
Main Board, Drawing 347 x 600	BOARD	Assembled Board	5347-314
CAPACITORS	C011	100pF, 100V	04-5661
	C012	47pF, 100V	04-5660
	C021	0.1UF, 50V	04-5663
	C022	0.001UF, 100v	04-5659
	C023	0.01UF, 50V	04-5664
	C025-C026	0.001UF, 100V	04-5659
	C027	10 UF, 20V	04-5655
	C031	10 pF, 100V	04-5673
	C032	100PF, 3KV	04-5532
	C1	1UF, 16V	04-5701
	C111-C112	47PF, 100V	04-5660
	C121-C123	47PF, 100V	04 5660
	C131-C133	0.0047MF, 3KV	04-5547
	C211	0.01UF, 50V	04-5664
	C212	0.1UF, 50V	04-5663
	C213	0.01UF, 50V	04-5664
	C221	0.0047MF, 3KV	04-5547
	C222	0.01UF, 50V	04-5664
	C231-C233	0.0047MF, 3KV	04-5547
	C311	0.1UF, 50V	04-5663
	C312	0.01UF, 50V	04-5664
	C313-C314	27 PF, 100V	04-5658
	C321	0.01UF, 50V	04-5664
	C322	1 UF, 35V	04-5656
	C421	0.1UF, 50V	04-5663
	C422	1 UF, 35V	04-5656
	C423	10 UF, 20V	04-5655
	C424	68 UF, 6.3V	04-5654
	C431	68 UF, 6.3V	04 5654

Model 177-84 Alpha/Beta Ratemeter

	<u>Reference</u>	<u>Description</u>	<u>Part Number</u>
	C432	2700MF, 35V	04-5621
	C511	47MF, 10V	04-5666
DIODES	CR031	MMBD7000LT1	07-6355
	CR121-CR122	MMBD914L	07-6353
	CR231-CR235	GI250-2	07-6266
	CR421	MMBD914L	07-6353
	CR521	CXSH-4	07-6358
	CR531-CR532	CXSH-4	07-6358
TRANSISTORS	Q121	2N7002L	05-5840
	Q201	2N7002L	05-5840
	Q211	MMBT3904T	05-5841
	Q301	2N7002L	05-5840
	Q311	MMBT3904T	05-5841
	Q321	MMBT3904T	05-5841
	Q431	MJD210	05-5843
	Q501	2N7002L	05-5840
	Q521	MJD200	05-5844
RESISTORS	R001	1 MEG TRIMMER	09-6911
	R002	100K TRIMMER	09-6930
	R011	22.1K 1/8W 1%	12-7843
	R012	10K 1/8W 1%	12-7839
	R021	100 OHM 1/8W 1%	12-7840
	R022	22.1K 1/8W 1%	12-7843
	R023	10K 1/8W 1%	12-7839
	R024	22.1K 1/8W 1%	12-7843
	R025	10K 1/8W 1%	12-7839
	R031	392K 1/8W 1%	12-7841
	R032	10K 1/8W 1%	12-7839
	R033	33.2K 1/8W 1%	12-7842
	R034	10K 1/8W 1%	12-7839
	R035	33.2K 1/8W 1%	12-7842
	R036	22.1K 1/8W 1%	12-7843
	R037	1 MEG 1/4W 5%	10-7028
	R101	5K TRIMMER	09-6918
	R102	1.5K 1/8W 1%	12-7878
	R103	10K TRIMMER	09-6931
	R104	100K TRIMMER	09-6930
	R111-R112	100K 1/8W 1%	12-7834
	R121	100 OHM 1/8W 1%	12-7840
	R122	100K 1/8W 1%	12-7834

Model 177-84 Alpha/Beta Ratemeter

<u>Reference</u>	<u>Description</u>	<u>Part Number</u>
R123	22.1K 1/8W 1%	12-7843
R124	100K 1/8W 1%	12-7834
R131	4.7 MEG 1/4W 5%	10-7030
R132	1 GIG-OHM FHV-1 2%	12-7686
R133	1 MEG 1/4W 5% CR25	10-7028
R134	1 GIG-OHM FHV-1 2%	12-7686
R201	5K TRIMMER	09-6918
R202	1 MEG TRIMMER	09-6911
R203	249K 1/8W 1%	12-7862
R204	1 MEG TRIMMER	09-6911
R211	221K 1/8W 1%	12-7845
R212	10K 1/8W 1%	12-7839
R213	4.75K 1/8W 1%	12-7858
R214	1M 1/8W 1%	12-7844
R216	301 OHM 1/8W 1%	12-7863
R217	1K 1/8W 1%	12-7832
R218-R219	10K 1/8W 1%	12-7839
R301	1M 1/8W 1%	12-7844
R302	1 MEG TRIMMER	09-6911
R303	1M 1/8W 1%	12-7844
R304	200K TRIMMER	09-6912
R305	1 MEG TRIMMER	09-6911
R306	249K 1/8W 1%	12-7862
R311	10K 1/8W 1%	12-7839
R312	301 OHM 1/8W 1%	12-7863
R314	1K 1/8W 1%	12-7832
R315	1M 1/8W 1%	12-7844
R316	4.75K 1/8W 1%	12-7858
R317	10K 1/8W 1%	12-7839
R318	221K 1/8W 1%	12-7845
R321	1M 1/8W 1%	12-7844
R322	22.1K 1/8W 1%	12-7843
R401	1 MEG TRIMMER	09-6911
R402	5K TRIMMER	09-6918
R421	2.21K 1/8W 1%	12-7835
R422	200 OHM 1/8W 1%	12-7846
R501	10K 1/8W 1%	12-7839
R511	22.1K 1/8W 1%	12-7843
R512	24.3K 1/8W 1%	12-7867
R521	22.1K 1/8W 1%	12-7843
R522	1K 1/8W 1%	12-7832
R523	165K 1/8W 1%	12-7877
R524	2.2 OHM 1/8W 5%	12-7932
R2110	10K 1/8W 1%	12-7839

Model 177-84 Alpha/Beta Ratemeter

NETWORK	RN401	220K	12-7923
TRANSFORMERS	T331	XFMR-L8050	40-0902
	T501	XFMR-Model 177 AUDIO	4275-083
SWITCHES	S401	90HBW04S	08-6709
	S501	NC3KR16B	08-6757
CONNECTORS	P1	640456-4 MTA100 WHITE	13-8088
	P2	1-640456-1 MTA100 WHITE	13-8059
	P3	640456-7 MTA100 WHITE	13-8115
	P4	640456-2 MTA100 WHITE	13-8073
INTEGRATED CIRCUITS	U011	LM285M-2.5	06-6291
	U021-U021	TLC372ID	06-6290
	U031	CA3096M	06-6288
	U111	CD74HC4538M	06-6297
	U121	CD74HC4538M	06-6297
	U211	TLC372ID	06-6290
	U212	IC- TLC27M7ID	06-6292
	U321	IC- TLC27M7ID	06-6292
	U411	P89V51RD2FA	06-6303
	U511	IC- TLC372ID	06-6290
	U521	IC- ICL7663SCBA	06-6302
VOLTAGE REGULATOR	VR421	LT1129CQ-5	06-6372
CRYSTALS	Y311	6.144 MHZ	01-5262
MISCELLANEOUS	RT215	03006 165.9 55 G100	07-6366
	RT313	03006-165.9-55-G100	07-6366
	MECH1	44P PLCC T/R REEL	06-6613
Front Panel Board, Drawing 347 x 244	BOARD	Assembled Board	5347-316
CAPACITORS	C110	100 μ F, 35V	04-5595

Model 177-84 Alpha/Beta Ratemeter

	<u>Reference</u>	<u>Description</u>	<u>Part Number</u>
LEDS	DS113	LED-E112	07-6390
	DS114	LED-E112	07-6390
	DS115	LED-E112	07-6390
	DS116	LED-E116	07-6393
	DS117	LED-E116	07-6393
	DS118	LED-E116	07-6393
	DS119	LED-E176 RED	07-6362
	DS120	LED-E176 RED	07-6362

RESISTORS	R123	150 OHM 1/4W 5%	10-7005
	R124	150 OHM 1/4W 5%	10-7005

SWITCHES	S122	92-851.342 ELEMENT	08-6726
----------	------	--------------------	---------

NETWORK	U112	820 OHM, 16P	12-7716
---------	------	--------------	---------

INTEGRATED CIRCUITS	U125	SN75512BN	06-6369
---------------------	------	-----------	---------

**Chassis Wiring
Diagram,
Drawing 347 x 243**

AUDIO

DS1	TEC-3526-PU	21-9251
-----	-------------	---------

CONNECTORS

J1	CONN-640428-4 MTA 100	13-8067
J2	CONN-1-640442-1 MTA100	13-8137
J3	CONN-64442-7 MTA100	13-8172
J4	CONN-640442-2 MTA-100	13-8178
J5-J6	CONN-640442-7	13-8172
J8	SERIES "C" UG706/U	13-7751
J9	TINI-JAK #41	21-9287

SWITCHES	S1	Power	08-6715
	S2	Meter Mode	08-6514

MISCELLANEOUS

M1	METER ASSY Model 177	4173-166
*	MAIN BOARD MODEL 177-84	5347-314
*	FRONT PANEL BOARD Model 177-84	5347-316

Model 177-84 Alpha/Beta Ratemeter

<u>Reference</u>	<u>Description</u>	<u>Part Number</u>
*	FRONT CHASSIS HARNESS Model 177-84	8347-327
*	REAR CHASSIS HARNESS MODEL 177-84	8347-323
B1	BATTERY NP1-6 YUASA	21-9385
F1	FUSE 1 AMP 5X20mm	21-9704
T1	TRANSFORMER	22-9908

Section

8

Appendix

Appendix 1: Checkout Procedure

1. Check all connections. Install the microprocessor chip 87C51FC with program firmware #34700N00 (or greater), and turn instrument ON with battery disconnected and the red positive lead to the battery attached to a +6 Vdc power supply. Check for +5 V at pin 1 of the LT1129CQ-5 regulator and +2.5 Vdc at pin 8 of the LM285-2.5 V. The current measured from the power supply should be less than 40 mA (peaking at 60 mA with the LEDs on). The LOW BATTERY LED should turn ON whenever the battery voltage is at or below 5.5 Vdc. Turn instrument OFF.
2. Disconnect the power supply. Attach the 120 Vac power cord and turn the instrument ON. The DC input voltage at pin 5 of the LT129CQ-5 from the transformer should be approximately 9.5 Vdc within 1.5 Vdc. Rotate the pot labeled BAT until the voltage at the positive lead to the battery is 6.9 Vdc. Turn instrument OFF.
3. With the instrument in an upright position, zero both meters using the zero adjust screw at the lower front of each meter. Set the dipswitch #3 (CALIBRATE) to ON. Turn the METER MODE switch to the RATEMETER position. Move the OPERATE MODE switch to the OPERATE position.
4. Turn the instrument ON. The power-on test by the microprocessor should light all the front-panel LEDs and briefly drive both meters full scale. In CALIBRATE mode, both meters should then be driven full scale. Adjust the pot labeled AMC (Alpha Meter Cal) until the alpha meter is full scale. Adjust the pot labeled BMC (Beta Meter Cal) until the beta meter is full scale. Turn the instrument OFF, and move dipswitch #3 to the OFF position.
5. Connect the instrument to a Ludlum Model 500 pulser set at 60 mV pulse height and 100 cpm. Rotate the pots labeled AAP (Alpha Alarm Point), BAP (Beta Alarm Point), and OL (OverLoad) fully clockwise. Rotate the VOL (audio Volume) pot fully clockwise, then turn back two full turns. Turn the instrument ON. Adjust the HVS (High Voltage Set) pot and the HVL (High Voltage Limit) pot until the high voltage read by the Model 500 is about 2300 Vdc within 200 Vdc. Check that

Model 177-84 Alpha/Beta Ratemeter

there are no shorts present in the HV section or in the coax connection to the detector connector. Set the high voltage to 1750 Vdc. Turn the METER MODE switch to READ HV. Adjust the HVR (High Voltage Read) until the beta meter reads 1.75 kV. Turn the METER MODE switch back to RATEMETER Mode.

6. Adjust the AT (Alpha Threshold) pot until the instrument reads 100 cpm with the incoming 60 mV pulsed. Change the Model 500 to output 2.5 mV pulses at 10,000 cpm. Adjust the BT (Beta Threshold) until the beta meter shows 10K cpm. Set the Model 500 to 25 mV pulse height and adjust the BW (Beta Window) pot so that beta pulses are counted between 2/5 mV and 25 mV. The complete adjustment ranges are:
 - Alpha Threshold (AT) from approximately 3 mV to 180 mV
 - Beta Threshold (BT) from approximately 0.5 mV to 4 mV
 - Beta Window (BW) from approximately 4 mV to 70 mV
7. Turn the METER MODE switch to the READ ALARM position. Adjust the AAP pot fully counterclockwise and fully clockwise. Ascertain that the alpha meter extends from 0 to full scale. Set the alarm to two-thirds scale. Repeat this process for the BAP pot and the beta alarm. Turn the METER MODE switch back to the RATEMETER setting.
8. Rotate the pot OL counterclockwise until you reach a point where the Overload LED turns on and both meters go full scale. Rotate the OL pot back clockwise for one full turn.
9. Set the internal rotary count switch to 0. Set the dip switch to:
 - 1=OFF
 - 2=ON-----beta divide by 10
 - 3=OFF-----no cal mode
 - 4=ON-----batching alarm mode
10. Use a shorted plug or a count switch plugged into the back of the instrument at the jack labeled COUNT SWITCH to start/stop frisking. Verify that during counting the audio turns ON and the COUNTING light turns ON. The meters should also subtract out the background while counting. Input 10 kcpm beta pulses and toggle dip switches #1 and #2 to see that the beta divide-by can be set to 1, 10, 100, or 1000. Return the dip switches #1 and #2 to OFF, ON.
11. Cause an alarm by COUNTING and increasing the input pulse rate. Verify that the latching alarm mode retains the alarm after the meter decreases below the alarm point. Verify that the ACK/RESET quiets the alarm audio with the first press, the clears the alarm LED with the second press. Switch dipswitch #4 to OFF to put the instrument into non-latching alarm mode and verify that the alarm is non-latching.

Model 177-84 Alpha/Beta Ratemeter

12. Set the internal rotary count switch to 1. Start COUNTING. The CHECK OK should turn ON after 8 seconds and a double-beep should sound. Start COUNTING again, but let off of the count switch before the 8 seconds is up, and see if the INCOMPLETE LED turns ON with a low triple-beep. Set the internal count switch to 2 (16 seconds) and then F (120 seconds) and verify the count times with a stop watch. Reset the rotary count switch to 0.
13. Burn the instrument in overnight and recheck the +5 Vdc, +2.5 Vdc, and the 1750 Vdc.

Appendix 2: Model 177-84 Mode Switch Addition

The Mode Switch addition on the Model 177-84 allows the user to switch the instrument between the Frisk Mode and the Operate Mode.

In the Frisk Mode, the count switch is held closed until the instrument is switched back to the Operate Mode. This allows the user to use the detector continuously without having to hold the count switch closed at the same time.

In the Operate Mode, whatever count switch is attached to the instrument will be closed as long as the switch is held down. This addition was originally put on the Model 177-84 so that it would work better with the Model 4902 Hand & Foot Detector Stand. The user can put the Model 177-84 into Frisk Mode and then remove the hand detector from its cradle and use it as a frisker. Without this addition, the user would have been required to hold his foot on the foot detector of the Model 4902 the entire time that he was frisking with the hand detector. The foot detector of the Model 4902 actuates the count switch.

Electronically, the only change is that a toggle switch is wired in parallel with the Count Switch connector on the rear of the instrument. Mechanically, the toggle switch and a silk-screened plate is mounted on the rear of the instrument. Mechanically, the toggle switch and a silkscreened plate is mounted on the front of the instrument.

The part number for the Mode Switch Addition is 4347-366.

Appendix 3: Model 4902 Specifications

The Model 4902 is a stand that holds two gas proportional detectors, one upper detector and one lower detector. The upper detector sets in position to be used as a hand detector, or it can be removed and used as a frisker. The foot detector has a switch mounted underneath so that count timer is started when the detector is pushed down. There are no counting electronics included with the Model 4902. If a count timer is required, the instrument used with the Model 4902 must have that capability. An instrument typically used with the Model 4902 is a Ludlum Model 177-84. Other instruments can be used.

Specifications

Upper Detector:	200 cm ² active area 79% open screen, 0.076 cm (0.030 in.) thick Efficiencies (4 π): 20% for ⁹⁰ Sr; 28% for ⁹⁹ Tc; and 13% for ²³⁹ Pu Attached with 1.8 m (6 ft) cable
Lower Detector:	Approximately 520 cm ² active area 63% open screen, 0.26 cm (0.104 in.) thick Efficiencies (4 π) 9% for ⁹⁰ Sr; 14% for ⁹⁹ Tc; and 4% for ²³⁹ Pu
Background:	With both detectors connected, < 10 cpm alpha, approximately 1000 cpm beta
Gas Flow:	Bubbler indicator, typically 10 cc/min or less consumption Supply connector: Colder Products PMC 22-02
Count Switch:	Normally open, TINI_JAK #41 phone plug as connector. Actuated by stepping on foot detector.
Instrument Power:	115 Vac outlet with a 1 A fuse

Section

9

Diagrams and Drawings

Main Board, Drawing 347 x 600 (3 sheets)

Main Board Component Layout, Drawing 347 x 243A (2 sheets)

Front Panel Board, Drawing 347 x 244

Front Panel Board Component Layout, Drawing 347 x 258A (2 sheets)

Wiring Diagram, Drawing 347 x 243

1

2

3

4

5

A

A

B

B

C

C

D

D

E

E

347314R4P2
347314R4P2.SchDoc

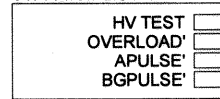

347314R4P3
347314R4P3.SchDoc

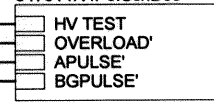

3

Mech1



44P PLCC T/R REEL

9-6-23

		LUDLUM		PO Box 810	
		MEASUREMENTS, INC.		501 Oak Street	
				Sweetwater, Texas 79556	
				U.S.A. 1-800-622-0828	
Drawn: PAB	2-17-17	Title: Main Board			
Design: RSS	11-14-95	Model: 177-84			
		Board#: 5347-314			
Approve: J.M.	9/6/2023	Sheet: 1	of 3	Series	Sheet
Print Date: 9/6/2023	9:02:31 AM	Rev: 4			
W:\Projects\LM\MM 177-84\5347-314\Rev4\347314R4P1.SchDoc		347	600		

1

2

3

4

5

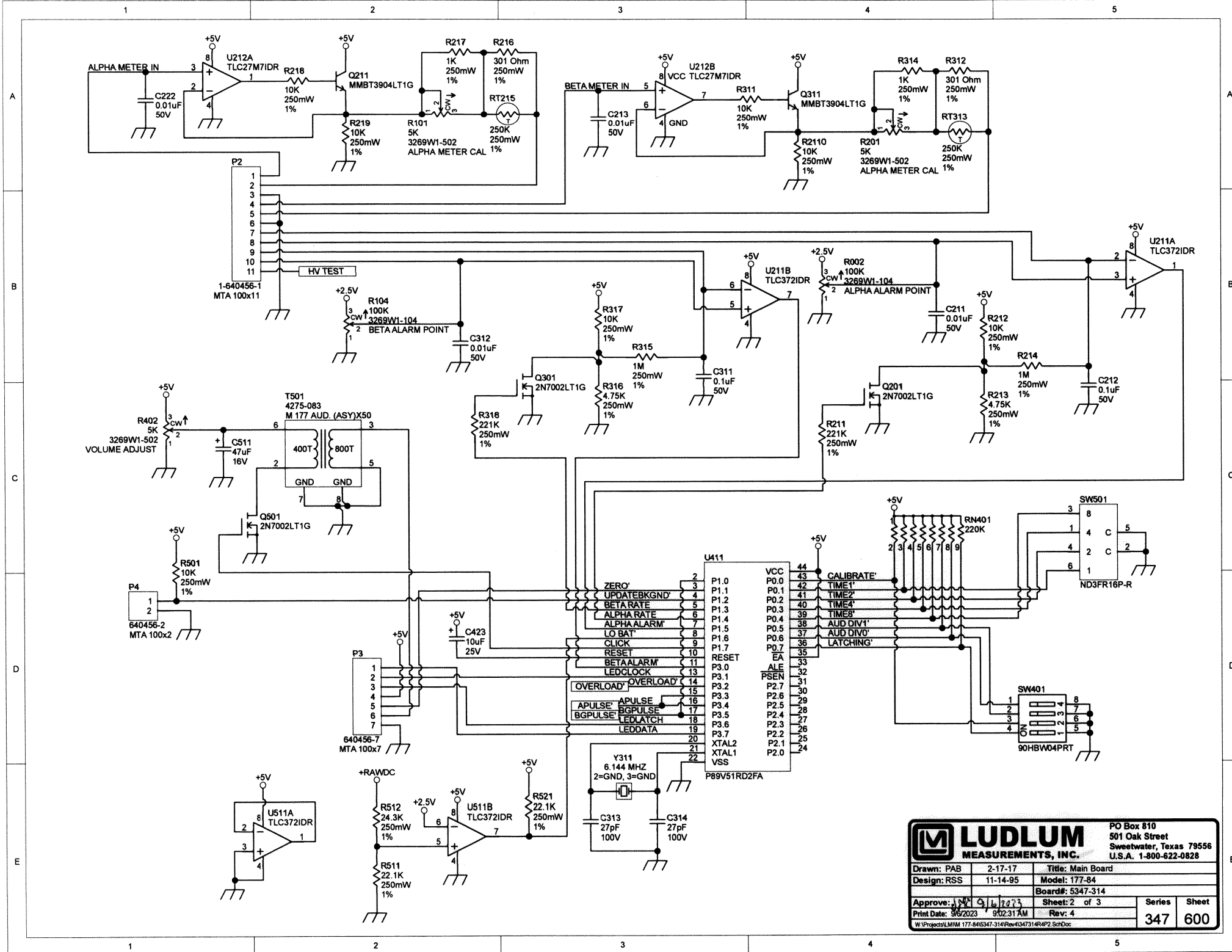

LUDLUM		PO Box 810	
MEASUREMENTS, INC.		501 Oak Street	
		Sweetwater, Texas 79556	
		U.S.A. 1-800-622-0828	
Drawn: PAB	2-17-17	Title: Main Board	
Design: RSS	11-14-95	Model: 177-84	
Approve: <i>[Signature]</i>		Board#: 5347-314	
Print Date: 9/6/2023	9:02:31 AM	Sheet: 2 of 3	Series
W:\Projects\LMHM 177-84\5347-314\Rev\1347314R4P2 Sch.Doc		Rev: 4	Sheet
		347	600

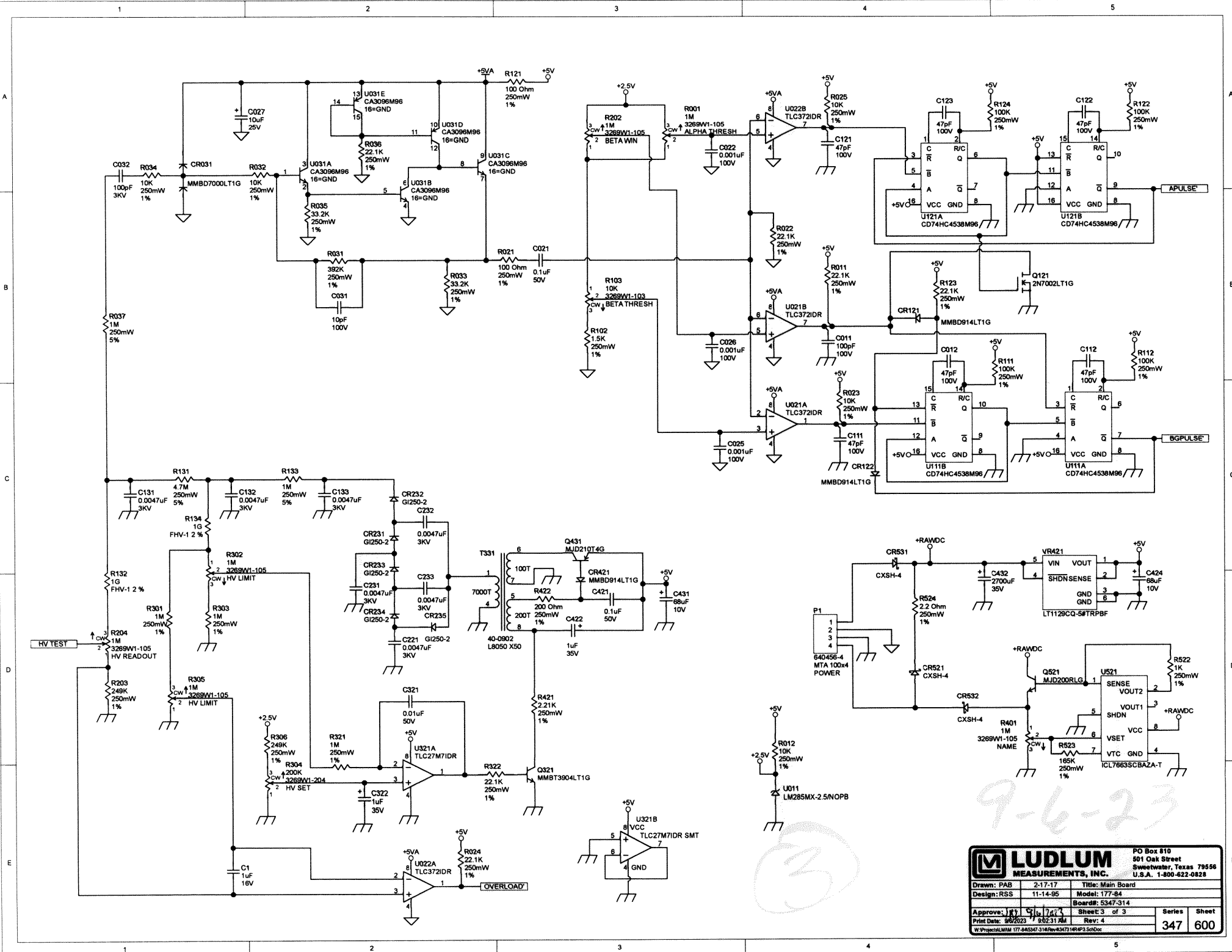

9-6-23

LUDLUM MEASUREMENTS, INC.		PG Box 810 401 Oak Street Sweetwater, Texas 79566 U.S.A. 1-800-622-0828	
		Drawn: PAB 2-17-17	Title: Main Board
Design: RSS 11-14-95	Model: 177-84	Board#: 5347-314	
Approves: [Signature] 11/16/95	Sheet: 3 of 3	Series	Sheet
Print Date: 8/6/2023 8:02:31 AM	Rev: 4	347	600
www.ProjectLUDLUM 177-845347-314 Rev: 4/3/23 10/16/23 5/6/23			

Top Layer (Scale 1.4:1)

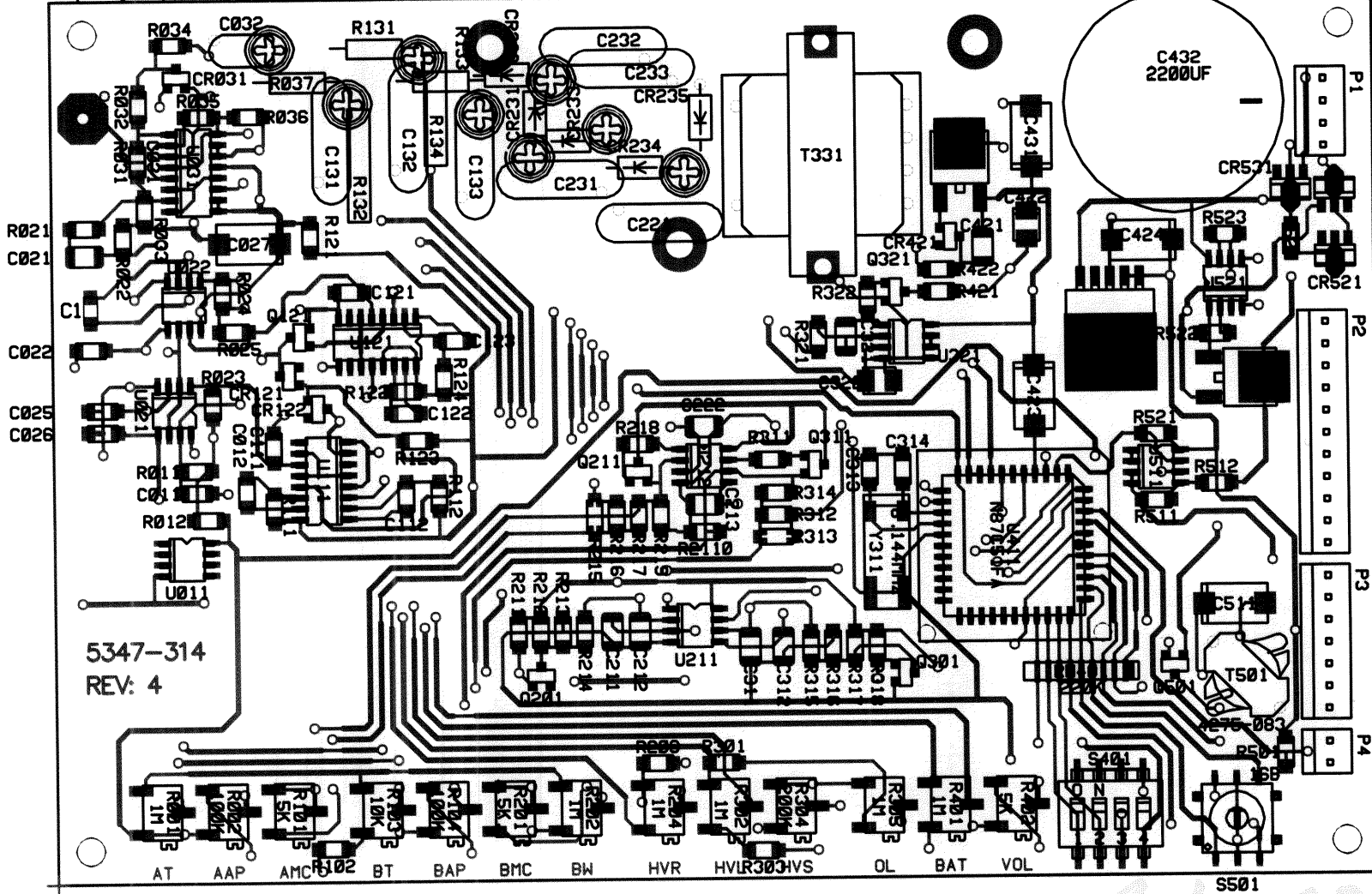

5347-314
REV: 4

M LUDLUM MEASUREMENTS				
Part: 5347-314		Model: 177-84		
Desc: Main Board				
Design: RSS	Date: 11/14/95	Rev:	4	
Drawn: PAB	Date: 9/6/2023	SHEET	SERIES	SHEET
Apr: JML	Date: 9/6/2023	1 of 4	347	243A
W:\Projects\LM\177-84\5347-314\Rev4				

Bottom Layer (Scale 1.4:1)

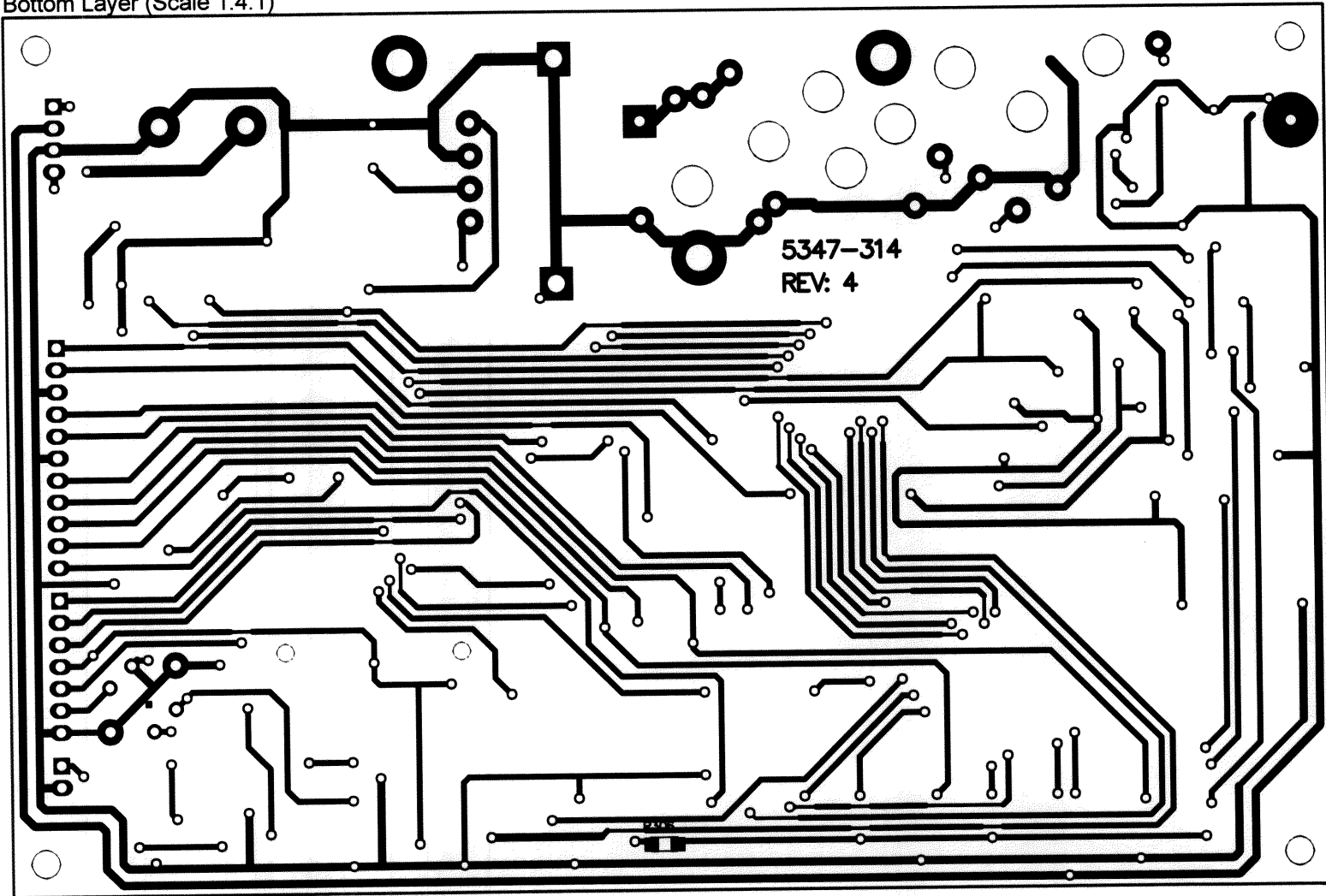

5347-314
REV: 4

 LUDLUM MEASUREMENTS				
Part: 5347-314		Model: 177-84		
Desc: Main Board				
Design: RSS	Date: 11/14/95	Rev:	4	
Drawn: PAB	Date: 9/6/2023	SHEET	SERIES	SHEET
Apr: JME	Date: 9/6/2023	2 of 4	347	243A
W:\Projects\LM\177-84\5347-314\Rev4				

REVISIONS						
EFF	AUTHORITY	ZONE	LTR	DESCRIPTION	DATE	APPROVED

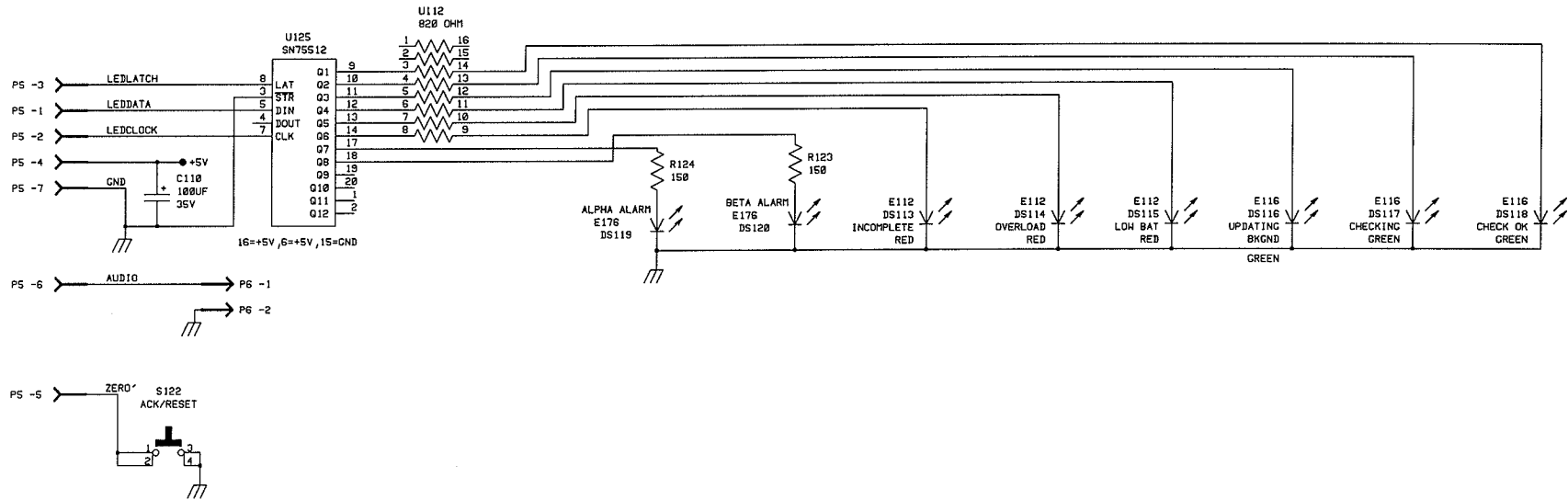

UPDATED -		LUDLUM MEASUREMENTS INC.	
DR	RSS	11-14-95	TITLE: FP BOARD
CHK	R.C	013096	
DSCN	RSS	11-14-95	BOARD# 5347-316
APPD	Jew	13196	
NEXT HIGHER ASSY.	-	SIZE D	MODEL 177-B4
		SERIES 347	SHEET 244
10:53:03	29-Jan-96	SB347316	SHEET 1 OF 1

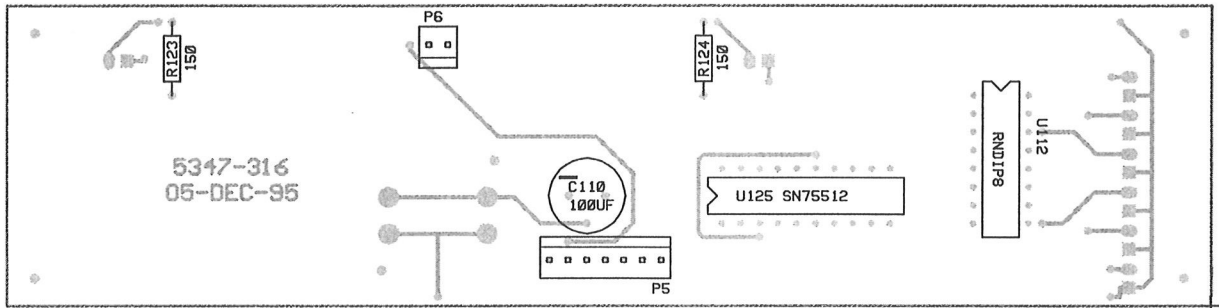

		PO Box 810 501 Oak Street Sweetwater, TX 79556 U.S.A. 1-800-622-0828	
		Title: Front Panel Board	
Drawn: CKB	12/05/95	Model: 177-84	
Design: RSS	11/14/95	Board#: 5347-316	
Approve: <i>RSS</i>	<i>12/02/95</i>	Rev: 1	
<i>PCBA Drawing</i>		SCALE: 0.99	Series Sheet
Print Date: 6/22/2015	2:43:49 PM	Bottom Overlay	347 258A
<small>W:\Projects\LLMM 177-84\5347-316\Rev1\347316R1_Assy_PcbDoc</small>			

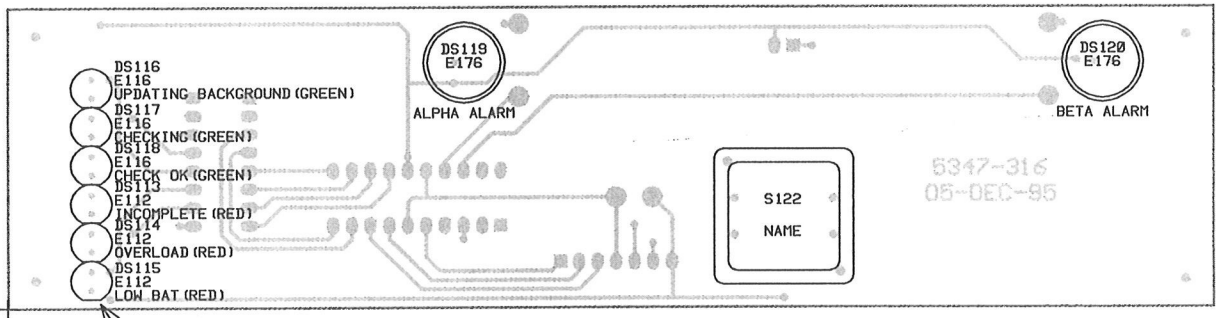

Place 5ea. LED Spacers (18-9096)
on each leg of LEDs. (60 Total)

 LUDLUM MEASUREMENTS, INC.		PO Box 810 501 Oak Street Sweetwater, TX 79556 U.S.A. 1-800-622-0828	
Title: Front Panel Board			
Drawn: CKB	12/05/95	Model: 177-84	
Design: RSS	11/14/95	Board#: 5347-316	
Approve: <i>[Signature]</i>	<i>[Signature]</i>	Rev: 1	
PCBA Drawing		SCALE: 0.99	Series Sheet
Print Date: 6/22/2015 2:43:47 PM		Top Overlay	347 258A
<small>W:\Projects\MMM 177-84\5347-316\Rev1\347316R1_Assy.PcbDoc</small>			

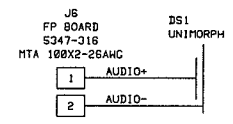
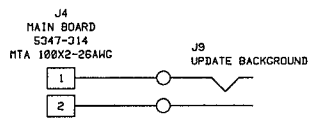
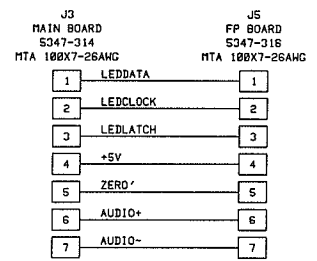
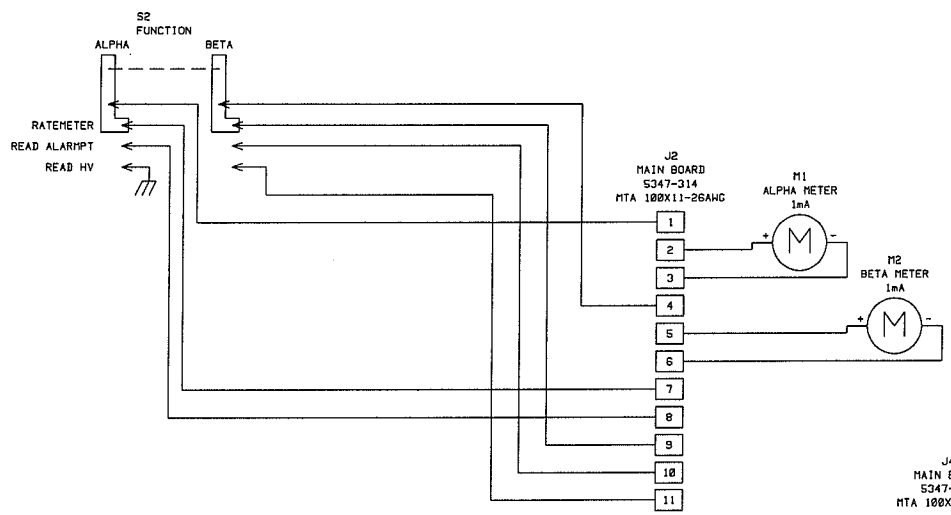
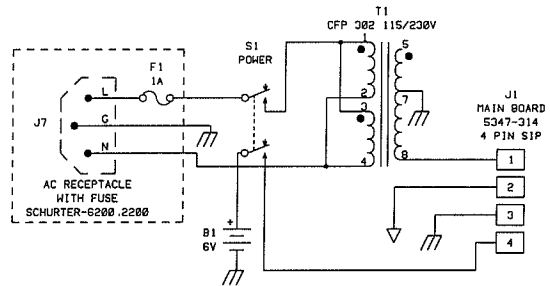

UPDATED -			LUDLUM MEASUREMENTS INC.			
DR	CKB	12/88/95	TITLE: WIRING DIAGRAM			
CHK	RDS	8/27/96				
DSGN	RSS	11-15-95	BOARD#	347-315		
APPD	J6W	1/21/96	SIZE	MODEL	SERIES	SHEET
NEXT HIGHER ASSY.	-	-	D	177-84	347	243
10:51:50	29-Jan-96	W347315	SHEET 1 OF 1			