

# **Model 3019 Digital Background Survey Meter**

**Ludlum Measurements**

**August 2023**

**Serial Number: 25023213 and Succeeding**

**Firmware: n42.4810 and Higher**



# Model 3019 Digital Background Survey Meter

Ludlum Measurements

August 2023

Serial Number: 25023213 and Succeeding

Firmware: n42.4810 and Higher



**LUDLUM MEASUREMENTS, INC**  
501 OAK STREET, P.O. BOX 810  
SWEETWATER, TEXAS 79556  
325-235-5494, FAX: 325-235-4672





## **STATEMENT OF WARRANTY**

Ludlum Measurements, Inc. warrants the products covered in this manual to be free of defects due to workmanship, material, and design for a period of twelve months from the date of delivery. The calibration of a product is warranted to be within its specified accuracy limits at the time of shipment. In the event of instrument failure, notify Ludlum Measurements to determine if repair, recalibration, or replacement is required.

This warranty excludes the replacement of photomultiplier tubes, G-M and proportional tubes, and scintillation crystals which are broken due to excessive physical abuse or used for purposes other than intended.

There are no warranties, express or implied, including without limitation any implied warranty of merchantability or fitness, which extend beyond the description of the face thereof. If the product does not perform as warranted herein, purchaser's sole remedy shall be repair or replacement, at the option of Ludlum Measurements. In no event will Ludlum Measurements be liable for damages, lost revenue, lost wages, or any other incidental or consequential damages, arising from the purchase, use, or inability to use product.

## **RETURN OF GOODS TO MANUFACTURER**

If equipment needs to be returned to Ludlum Measurements, Inc. for repair or calibration, please send to the address below. All shipments should include documentation containing return shipping address, customer name, telephone number, description of service requested, and all other necessary information. Your cooperation will expedite the return of your equipment.

**LUDLUM MEASUREMENTS, INC.**

**ATTN: REPAIR DEPARTMENT**

**501 OAK STREET**

**SWEETWATER, TX 79556**

**800-622-0828**

**325-235-5494**

**FAX 325-235-4672**



REVISION HISTORY

REV	DESCRIPTION	DATE	BY
1	VALID	3/21/14	DDW
2	ECF# 3778	10/8/15	WJM
3	ECF# 3951	1/13/16	WJM

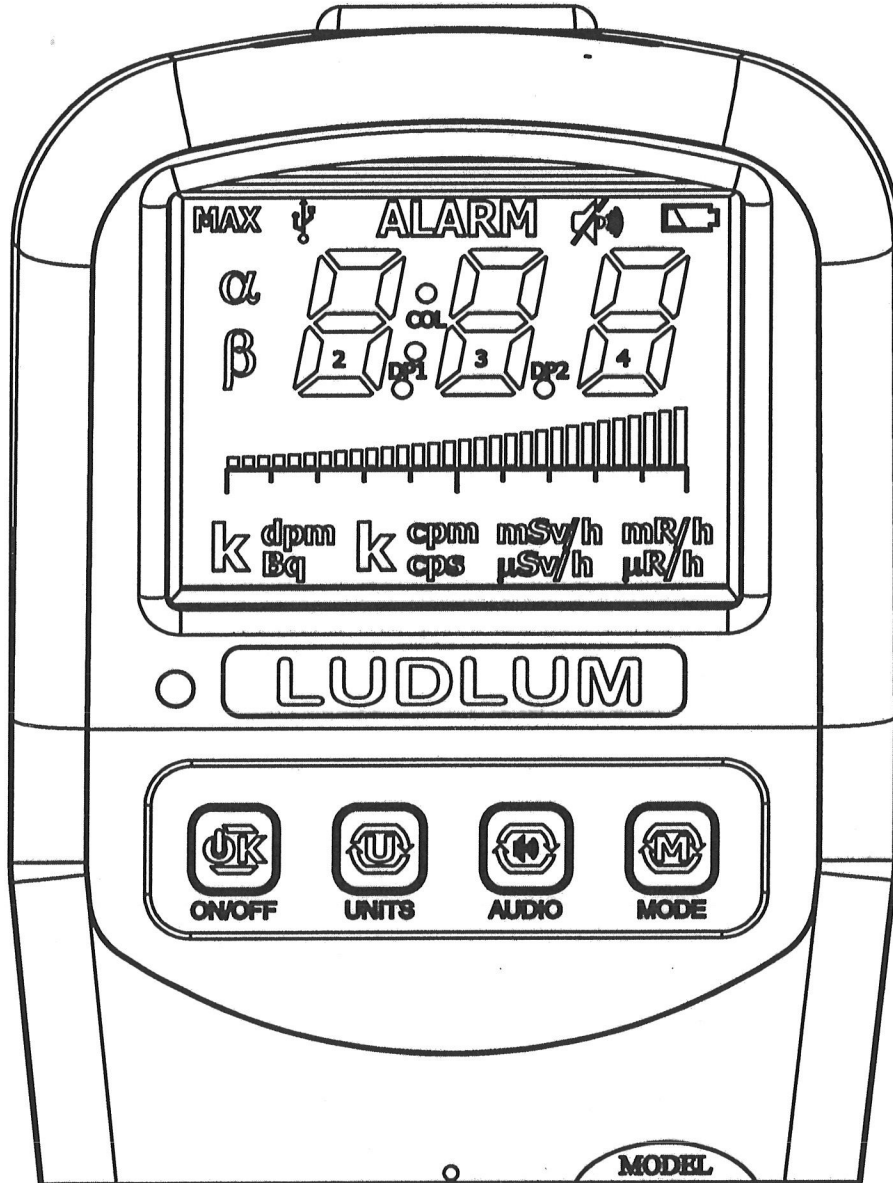

DWN	DATE	CHK	DATE	APP	DATE
WJM	5/26/16			WJM	5-26-16
DWG NUM: 4498-593				SCALE: 1:1	
TITLE M 3019 FRONT PANEL					
 LUDLUM MEASUREMENTS, INC. 501 OAK STREET SWEETWATER, TEXAS 79556			SERIES	SHEET	
			498	593J	



REVISION HISTORY			
REV	DESCRIPTION	DATE	BY
1	VALID	3/21/14	DDW
2	ECF# 3778	10/8/15	WJM
3	ECF# 3951	1/13/16	WJM

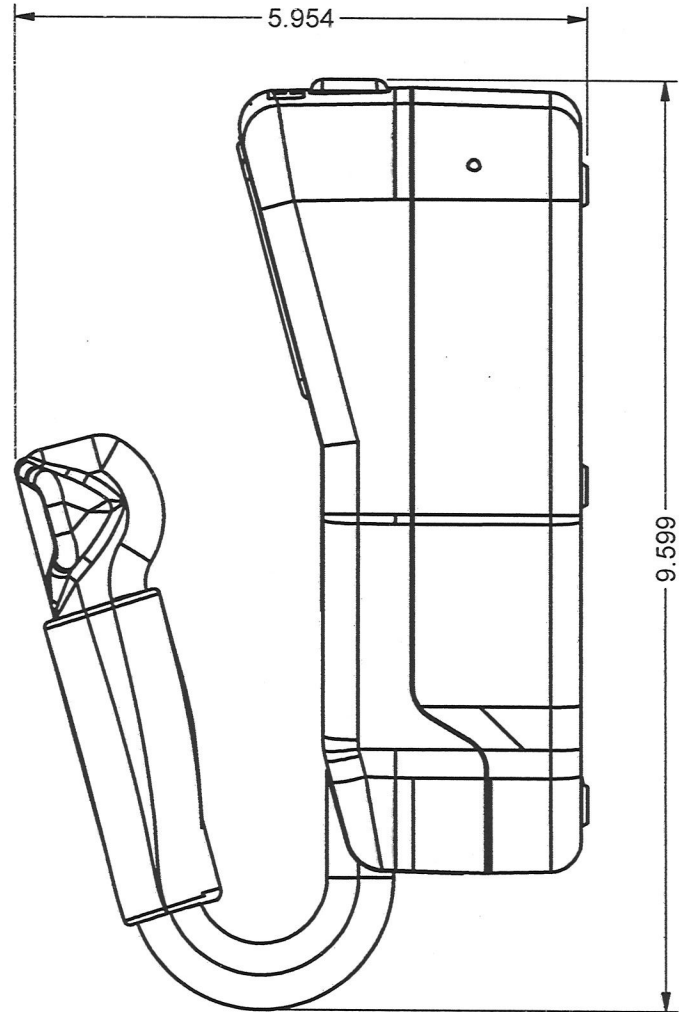
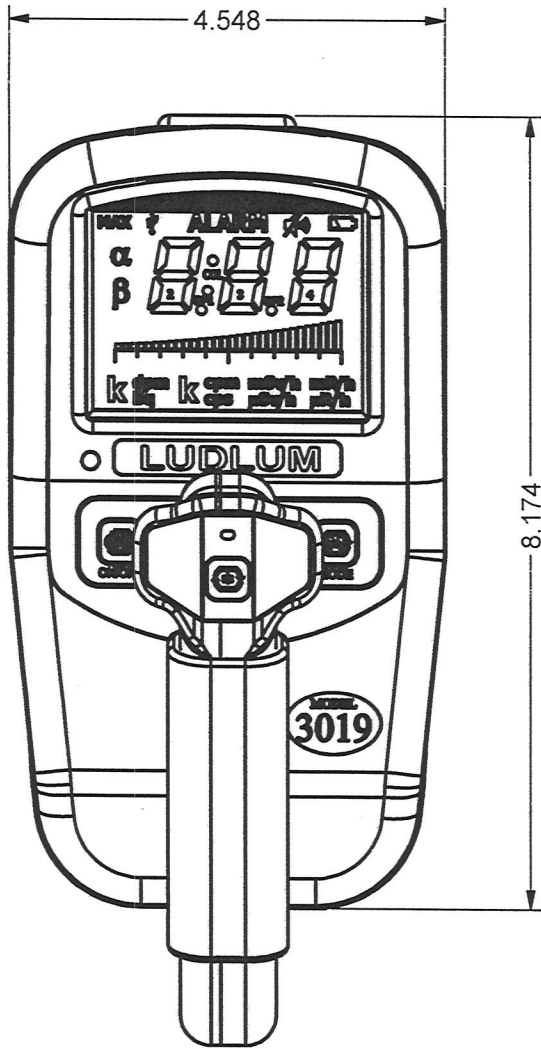

DWN	DATE	CHK	DATE	APP	DATE
WJM	5/26/16			WJM	5-26-16
<b>DWG NUM: 4498-593</b>				<b>SCALE: 1/2</b>	
<b>TITLE M 3019 OVERALL DIMENSIONS</b>					
 LUDLUM MEASUREMENTS, INC. 501 OAK STREET SWEETWATER, TEXAS 79556		SERIES	SHEET		
		498	593K		



# CONTENTS

<b>Contents</b>	<b>3</b>
<b>List of Figures</b>	<b>5</b>
<b>List of Tables</b>	<b>7</b>
<b>1 Introduction</b>	<b>9</b>
<b>2 Getting Started</b>	<b>11</b>
2.1 Unpacking and Repacking . . . . .	11
2.2 Battery Installation . . . . .	11
2.3 Instrument Operational Test . . . . .	12
2.3.1 Turning the Instrument On . . . . .	12
2.4 Sigma Audio . . . . .	14
2.5 Detector Failure Diagnostics . . . . .	14
2.5.1 Detector Loss of Count . . . . .	14
2.5.2 Detector Over Range . . . . .	15
2.5.3 Detector Overload . . . . .	15
2.6 Instrument Use And Controls . . . . .	16
2.6.1 ON/OFF Button: . . . . .	16
2.6.2 UNITS Button: . . . . .	17
2.6.3 AUDIO Button: . . . . .	18
2.6.4 MODE Button: . . . . .	18
2.6.5 LOG Button: . . . . .	19
2.7 RATE Mode Operation . . . . .	20
2.8 MAX Mode Operation . . . . .	21
2.9 COUNT Mode Operation . . . . .	21
<b>3 Specifications</b>	<b>25</b>
<b>4 Setup Mode</b>	<b>27</b>
4.1 Setup Overview . . . . .	27
4.2 Setup Parameters . . . . .	28
4.3 Entering Setup Mode . . . . .	29
4.4 Setup Mode Operation . . . . .	31
4.5 Model 3019 List of Parameters (in order) . . . . .	32
4.6 Setup Page 1 . . . . .	34
4.7 Setup Page 2 . . . . .	37
4.8 Setup Page 3 . . . . .	39
4.9 Setup Page 4 . . . . .	42
4.10 Setup Page 5 . . . . .	44
<b>5 Datalogging</b>	<b>45</b>

---

5.1	Datalogging Operation – Mode 1 . . . . .	45
5.2	Datalogging Operation – Mode 2 . . . . .	46
5.3	Datalogging Operation – Mode 3 . . . . .	47
5.4	Data Log Operation . . . . .	48
5.5	Format . . . . .	48
<b>6</b>	<b>Software</b>	<b>51</b>
6.1	Connecting to Lumatic 2.0 Calibration/Configuration Software . . . . .	51
<b>7</b>	<b>Advanced Features</b>	<b>53</b>
7.1	Dead Time Correction . . . . .	53
7.2	Units . . . . .	53
7.3	R to Sv Conversion . . . . .	54
7.4	Software Calibration Tools . . . . .	54
7.5	Hardware Correction . . . . .	54
7.6	Other Device Data . . . . .	54
7.7	Battery Life . . . . .	55
7.8	Real-time Streaming . . . . .	55
7.9	Button Mapping . . . . .	55
7.10	CPS Offset . . . . .	56
<b>8</b>	<b>Safety Considerations</b>	<b>57</b>
8.1	Environmental Conditions for Normal Use . . . . .	57
8.2	Warning Markings and Symbols . . . . .	57
8.3	Cleaning and Maintenance Precautions . . . . .	58
<b>9</b>	<b>Revision History</b>	<b>59</b>
<b>10</b>	<b>Recycling</b>	<b>63</b>
<b>11</b>	<b>Options</b>	<b>65</b>
<b>12</b>	<b>Standard Parts List</b>	<b>67</b>
<b>A</b>	<b>Energy Response</b>	<b>69</b>
A.1	Model 3019 Energy Response . . . . .	69



# LIST OF FIGURES

2.1	Startup Display (All Segments Shown)	12
2.2	Firmware Version Display	12
2.3	Battery Voltage Display	13
2.4	Startup Display Showing 189 Stored Data Records	13
2.5	Detector Loss of Count Display (Display Will Flash)	15
2.6	Detector Over Range (Display Will Flash)	15
2.7	Detector Overload Alarm (Display Will Flash)	16
2.8	RATE Mode Displaying Background Radiation Rate	20
2.9	MAX Mode Display With ALARM Indication	21
2.10	COUNT Mode Displaying COUNT Timer of 5 Minutes, 30 Seconds	24
4.1	Setup Page Selection Display (showing page 4-CAL)	31
5.1	Displaying Datalog Table Index of 12	46
5.2	Displaying Datalog Location ID Table Index of 36	47
A.1	Model 3019 Exposure	69
A.2	Model 3019 Ambient Dose	69



# LIST OF TABLES

2.1	COUNT Mode Units and Result . . . . .	23
4.1	Setup Parameters . . . . .	29
4.2	Primary Units and Multipliers . . . . .	37
4.3	Primary Unit Multipliers . . . . .	38
4.4	Secondary Units and Multipliers . . . . .	39
4.5	Secondary Unit Multipliers . . . . .	41
4.6	Response Time Based on Count Rate . . . . .	42
7.1	Features That Affect Units in All Modes . . . . .	54
12.1	Standard Parts List . . . . .	67



## INTRODUCTION

The Model 3019 is an ergonomic, lightweight instrument which can be used for background measurements of gamma radiation levels up to 500  $\mu\text{Sv/h}$  (50 mR/hr). The internal CsI scintillation detector has a sensitivity of 175 cpm per  $\mu\text{R/hr}$ . The Model 3019 features the ability to measure radiation in count rate, exposure rate/dose, activity rate, time-averaged rates, and scaler counts. The instrument features a large backlit LCD (liquid crystal display), an easy, intuitive use keypad, and audio feedback. The unit body is made of lightweight but durable plastic. It is intended for outdoor use and can resist splashing water. The foam grip provides a comfortable, ergonomic grip but may be removed for ease of decontamination.

Three modes of operation are available for the Model 3019 – RATE, MAX, and COUNT.

RATE mode operation will display the current count, exposure, or activity rate.

MAX mode is used to capture the highest count, activity, or exposure rate detected – useful for finding a peak rate, or frisking when the display is not visible. Two sets of units (primary and secondary) for RATE and MAX modes can be chosen from among cps, cpm, Bq, dpm, R/h, or Sv/h. The user can switch between these two units by simply pressing the UNITS button.

COUNT mode allows the user to perform a count for a predetermined time. Depending on the count units chosen, the result can be a scaler count (in counts or disintegrations), a time-averaged rate (cpm, dpm, Bq, cps), a time-averaged exposure or dose (R/h, Sv/h), or an integrated exposure or dose (R or Sv). The primary keypad includes four push buttons: ON/OFF to toggle instrument power, UNITS to change between available units, AUDIO to change audio levels, and MODE to switch between available modes.

The standard handle includes a LOG button that allows the instrument to log up to 1000 data points when activated with the optional Lumatic Datalogging Kit. The display will be automatically back-lit if light levels are low or can be set to a user defined light level. The display back-light can also be configured for “Continuous On” operation. RATE, MAX, and COUNT modes can be silent or utilize a “click” audio; the “click” audio is always silent during COUNT mode by default. A "sigma" audio mode can be enabled (disabling the "click" audio) in RATE and MAX modes when scintillator detectors are used, and this mode makes it easy for the user to find small increases above the background radiation level. In this mode, the instrument measures background for 8 seconds after power-up, and then beeps whenever

the rate increases by a small amount. Users are freed from watching the numeric value to "find" something. They can simply listen for multiple beeps. Setup of the instrument is accomplished through the front-panel buttons, or through Lumic 2.0 software available from Ludlum Measurements.

Front-panel setup can be disabled via the internal switch on the Model 3019 in order to protect settings from inadvertent changes. When the settings are protected, the user can view the settings or modify a limited number of settings as defined with the Lumic software. Using the Lumic software, the Model 3019 can be configured to allow changes to the alarms and/or count time even when in protect mode.

The unit is operated with four alkaline AA batteries for operation from -20 to 50 °C (-5 to 122 °F). Battery life is approximately 750 hours (as low as 100 hours w/backlight always on) under normal usage. A low-battery indicator on the LCD warns when less than 16 hours of battery life remain. The Model 3019 may optionally be provided with a 1/8-inch stereo headphone jack that would allow for headphone use for audio output. It is located near the left handle base.

If a headphone jack is not in use, the Model 3019 may optionally be provided with an RS-232 serial output for connection to PC or other electronic device. For more advanced use: See Appendix A for information on our Auxiliary Communications features, which allow the instrument to expand its capabilities with a variety of external devices through a standard serial interface.

## GETTING STARTED

### 2.1 Unpacking and Repacking

Remove the calibration certificate and place it in a secure location. Remove the instrument and ensure that all of the items listed on the packing list are in the carton. Check individual item serial numbers and ensure calibration certificates match between instruments and detectors (if applicable). The Model 3019 serial number is located on a label on the front side of the unit.

To return an instrument for repair or calibration, provide sufficient packing material to prevent damage to the instrument during shipment. Every returned instrument must be accompanied by an Instrument Return Form, which can be downloaded from the Ludlum website at [www.ludlums.com](http://www.ludlums.com). Find the form by clicking the "Support" tab and selecting "Service Department" from the drop-down menu. Then choose the appropriate form located under the "Returned Goods Form" heading.

### 2.2 Battery Installation

A low-battery indicator appears at the top of the LCD when less than 16 hours of battery life remain. When this indicator is present, follow these steps to replace the four standard AA batteries:

1. Turn off power to the instrument.
2. Turn the instrument over so that the bottom of the instrument is facing up.
3. Use a straight, medium-sized screwdriver to turn the single screw on the battery cover one-quarter turn counter-clockwise.
4. Release and remove the battery cover.
5. Replace all four AA batteries.
6. Replace the cover and turn screw one quarter of a turn clockwise to secure.

## 2.3 Instrument Operational Test

Once this procedure has been completed, the instrument is ready for use.

### 2.3.1 Turning the Instrument On

Turn the instrument ON by pressing the ON/OFF button for about a second, and then releasing. The instrument should activate all the LCD segments and the audio. Observe the device during this time. If any LCD segments are missing, or audio fails to work, the device is in need of repair. Please refer to Figure 2.1.

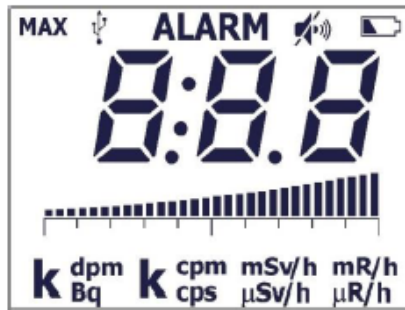

Figure 2.1: Startup Display (All Segments Shown)

The instrument then displays the firmware version. Please refer to figure below.

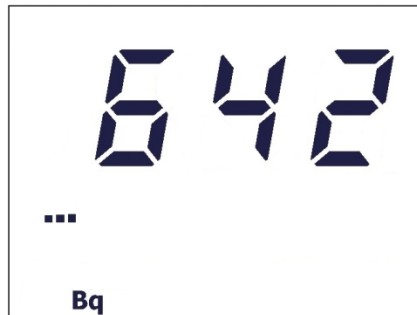

Figure 2.2: Firmware Version Display

**Note:** Firmware versions with Bq units are equipped with auxiliary communication.

Beginning with the n42 version firmware, the tick marks below the firmware number define the board generation which will help with future firmware updates. Once n42 is installed, the user will no longer have to open the instrument to determine which version of the main processor board was used in the instrument. Instead, use the following table to determine which main processor board is installed in the instrument:

- 1 tick - 5498-612
- 2 ticks - 5519-091
- 3 ticks - 5519-779



The instrument then displays the battery voltage. Please see Figure below.

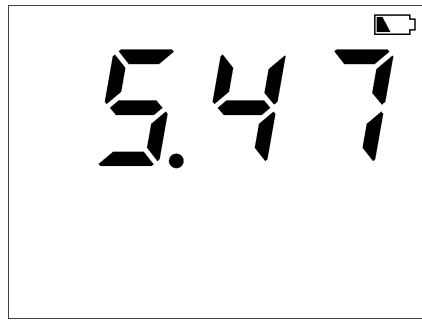

Figure 2.3: Battery Voltage Display

The instrument then displays the number of stored records if datalogging is enabled. Please refer to the figure below.



Figure 2.4: Startup Display Showing 189 Stored Data Records

The instrument will then move to normal operation, displaying the current rate for the Primary units (factory default: mR/h). This boot-up process takes about 5 seconds, plus another 8 seconds if Sigma Audio is enabled.

If the Sigma Audio option is selected, the unit will display a countdown from :08 to :01 (in seconds) as the unit measures background radiation levels.

Ensure that the low-battery indicator is not present. If the low-battery indicator is present, replace the batteries as soon as possible. Should the instrument detect a battery voltage that is high enough to power on, but too low to safely operate, the display will blank and the low-battery icon will flash. Normal operation will not be available until the batteries have been replaced. Under extreme low-battery conditions, be aware that the unit may not even turn on or may turn itself off abruptly.

To assure proper operation of the instrument and detector(s) between calibrations, an instrument operational check including battery test and instrument test should be performed at least daily or prior to use, whichever is less frequent. A reference reading (or readings) with a dedicated check source should be obtained with the detector(s) in a constant and reproducible manner at the time of calibration or at the time the instrument is received in the field.

If at any time the instrument fails to read within 20% of the reference reading when using the dedicated check source, it should be removed from service and sent to a calibration fa-

cility for recalibration and/or repair. If desired, multiple readings may be taken at different distances and/or with different sources so that other scales are checked.

Example of a Check Source reading:

Check Source # \_\_\_\_\_ Rate \_\_\_\_\_ Units \_\_\_\_\_

## 2.4 Sigma Audio

The Ludlum Model 3019 has the standard "click" audio that is widely used by radiation instruments; however, it also has a Sigma Audio mode that can be enabled to change the audio sound. This mode is useful for scintillation detectors because their high count rate makes the "click" audio less useful.

In the sigma audio mode, the instrument measures the background radiation for eight seconds on power-up, and then automatically sets a low threshold alarm rate above the background rate. Afterwards, the instrument will produce a beep any time that the instrument "sees" more than this threshold value. The user doesn't need to watch the display to find a small increase over background; the user may just listen for multiple beeps. Thus, the unit has an audio alarm that, on power-up, adjusts to just above the current background level and provides a sensitive audio indication to the user.

Note that this audio alarm can also work in conjunction with the fixed alarm, i.e. the user can have both a floating audio alarm (resulting in audio beeps) based on the background level, and a fixed tone audio and a steady ALARM icon when a predetermined fixed alarm level is exceeded.

## 2.5 Detector Failure Diagnostics

Note that the Model 3019 has its own diagnostic tests to ensure that the detector is functioning correctly.

### 2.5.1 Detector Loss of Count

If the detector stops detecting radiation for a settable number of seconds, the Model 3019 will flash the minimum display value to indicate which units have been affected by the loss of count event. This indication is common if the unit is powered up without a detector connected. If this indication is observed with a connected detector, remove the unit from service and have it evaluated by a qualified repair and calibration technician.

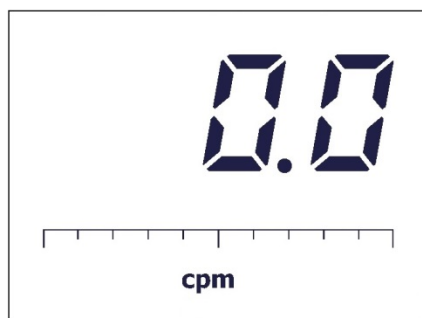

Figure 2.5: Detector Loss of Count Display (Display Will Flash)

### 2.5.2 Detector Over Range

If the detector is exposed to high levels of radiation or has an internal malfunction that causes it to count high or excessively, the unit flashes the maximum display value for the currently selected units as a warning. Additionally, the ALARM icon is displayed at the top of the screen, an audio alarm sounds (which can be silenced by a long press of the ON/OFF button), and the device status **OVERRANGE** is streamed or logged. The user should ensure whether this condition is being caused by a high radiation field, by a shorted cable, or by internal malfunction. If a Maximum Display parameter is set, then it is possible for the display to flash the Maximum Display value under this condition.

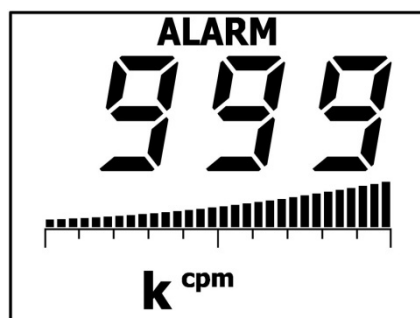

Figure 2.6: Detector Over Range (Display Will Flash)

### 2.5.3 Detector Overload

As another diagnostic test, the Model 3019 monitors the HV supply's detector current. A current overload threshold can be set via Setup Mode or Lumatic Software. (A setting of 0 disables this alarm.) In general, this alarm setting can be used to detect when there is some detector failure, a cable failure, or a possible high level of radiation. When this alarm is triggered, the LCD will display "OL" in place of the numerical values, and an alarm tone will sound. Once the detector current goes below the threshold, the Model 3019 will return to normal operation.



Figure 2.7: Detector Overload Alarm (Display Will Flash)

## 2.6 Instrument Use And Controls

With four front-panel buttons and one handle button (as seen in front-panel drawing in front of manual), the Ludlum Model 3019 offers many features in a small package. Each button may be pressed and held for a predetermined length of time, signified by instrument beeps, to access unique instrument features. As the button is pressed, the instrument will beep to indicate the user has reached a new level of button access.

- A short press and release, less than 1/2 second and before any instrument beeps occur, will activate the first level of button operation. When the button is released, a single beep will occur as an acknowledgement.
- A long press, greater than 1/2 second but less than 2 seconds, will force the instrument to emit one beep. Release the button after the beep to activate the second level of operation.
- An extra-long press, greater than 2 seconds and after the second instrument beep, will activate the highest level of operation. After the second beep, the button may be released.

By default, the majority of functions are assigned to short presses of the buttons.

### 2.6.1 ON/OFF Button:

Used to power the Model 3019 ON and OFF.

- Power On: Press for approximately one second and release.
- Power Off: Press and hold for approximately five seconds. The display will show a 3, 2, 1 countdown after the second beep. Releasing the ON/OFF button during shutdown will return the device to the previous state of operation. At completion of the shutdown count, the LCD will go blank (unless a USB cable is connected in which case the USB icon will flash).

**Short Press (press and release before one beep):**

- During normal operation, it will acknowledge/silence alarms in any mode of operation.
- Change Log Location selected position (If data logging mode 2 is enabled).
- Will move selection position in the device menu.

**Long Press (press and release after one beep):**

- In RATE mode, it will reset the currently displayed rate if the user has permission (permission set from Lumic 2.0 software). The minimum display will be shown before returning to the exposure rate.
- In RATE mode, when Sigma Audio is enabled, the instrument will take a new background reading and update the Sigma Audio level.
- In MAX mode, it will reset the current MAX value.
- In COUNT mode, it will:
  - If COUNT mode is ready: It will initiate the count.
  - If COUNT mode is in progress: It will stop the current count and reinitialize the instrument to begin the next count.
  - If COUNT mode is complete: It will reset the count mode and reinitialize the instrument to begin the next count.

**Extra-Long Press (press and release after two beeps):**

- Currently has no effect.

**2.6.2 UNITS Button:**

In default operation, the display shows the current exposure rate using the Primary units. A short press of the UNITS button (1 beep) will switch between Primary and Secondary units.

**Short Press (press and release before one beep):**

- Used to switch between Primary and Secondary units.

**Long Press (press and release after one beep):**

- Currently has no effect.

**Extra-Long Press (press and release after two beeps):**

- Enables/disables the Auxiliary Communications in conjunction with the Mode button.
- In Count mode with the timer ready, will increment through the available count times.
  - User defined.
  - 0 (minimum display) or Continuous Count
  - 6 seconds (0:06)
  - 30 seconds (0:30)
  - One minute (1:00)
  - Two minutes (2:00)
  - 5 minutes (5:00)
  - 10 minutes (9:60)

**Press and Hold:**

- In Count mode with the timer ready, continuing to hold the button after the second beep will allow the instrument to cycle through the available count times at approximately one-second intervals.

**2.6.3 AUDIO Button:**

The Audio button's primary function is to adjust the audio level of the instrument.

**Short Press (press and release before one beep):**

- During normal operation, it will increment the audio through available volume levels which include mute and high.

**Long Press (press and release after one beep):**

- Currently has no effect.

**Extra-Long Press (press and release after two beeps):**

- Device Menu: When viewing the detector current overload set point, this will switch the display between the live current reading and the set point value.

**2.6.4 MODE Button:**

The Mode button's primary function is to switch between available enabled modes.

**Short Press (press and release before one beep):**

- During instrument initialization and within 4 seconds after the power-up screen, three short presses of the MODE button will place the instrument into setup mode. Once the instrument is displaying normal operation, and 4 seconds have passed, the button can be used to advance to the next available mode.
- Used to advance between the three operating modes: RATE, MAX, and COUNT. While RATE must always be enabled, any combination of MAX and COUNT modes may be disabled from use.

**Long Press (press and release after one beep):**

- Currently has no effect.

**Extra-Long Press (press and release after two beeps):**

- Enables/disables the Auxiliary Communications in conjunction with the UNITS button.

**2.6.5 LOG Button:**

By default, the LOG button's primary function is to log an event or initiate a count in COUNT mode, which will be logged upon completion of the count (if data logging is enabled); however, the functionality of the LOG button can be configured in software to permit multiple functions to be assigned to the LOG button. This is referred to as Button Mapping. For more information on Button Mapping, please refer to Section 7.9. The default operation of the LOG button is as follows:

**Short Press (press and release before one beep):**

- In RATE mode, it will log the current rate reading if datalogging is enabled.
- In MAX mode, it will log the current MAX value if datalogging is enabled.
- In COUNT mode, it will:
  - If COUNT mode is ready: Initiate a count. Upon completion, the result will be logged if datalogging is enabled.
  - If COUNT mode is in progress: Button has no effect.
  - If COUNT mode is complete: Button will log the current result.
- If datalogging in Mode 2 and a log event has been initiated, the button is used to accept the current location ID.

**Long Press (press and release after one beep):**

- Currently has no effect by default.

**Extra-Long Press (press and release after two beeps):**

- Currently has no effect by default.

## 2.7 RATE Mode Operation

In RATE mode, the current count/exposure rate will be displayed. The maximum displayable value, regardless of units, is 999 k.

If an alarm is not in progress, a long press of the ON/OFF button will reset the averaged rate before releasing the button. The Reset feature must be enabled through Lumic 2.0 Calibration software and will be disabled when Sigma Audio is enabled.

A short press of the UNITS button will switch the displayed value between the Primary and Secondary Units.

A short press of the AUDIO button will toggle click audio between Off and On (Hi). When Sigma Audio is enabled, a short press of the AUDIO button will toggle the Sigma Audio volume levels.

If an alarm condition is present, a short press of the ON/OFF button will acknowledge and turn off the alarm audio. Under an alarm condition, the ALARM display indicator will be activated. There are two user settable alarms for both the primary and secondary units. If both alarms for a particular unit are set, the first alarm will activate beeping alarm audio and a flashing ALARM display indicator; If only one alarm is set or the second alarm is triggered, both the alarm audio and the ALARM display indicator are continuous. Alarms are non-latching in RATE mode.

When Sigma Audio is enabled, and an alarm condition is not present, a long press of the ON/OFF button will reset the Sigma Audio alarm level. The Sigma count can only be reset in RATE mode. If sigma audio and device rate reset are both enabled, the device rate reset will automatically be disabled.

If other operational modes are available, a short press of the MODE button will move to the next available operational mode.

By default, a short press of the LOG button, if datalogging is enabled, will log the currently displayed rate.

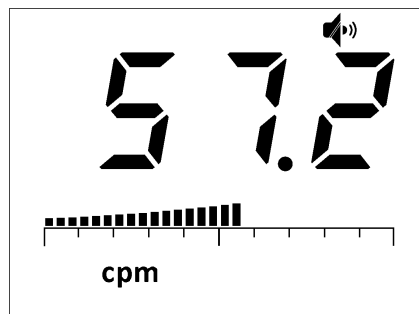

Figure 2.8: RATE Mode Displaying Background Radiation Rate



## 2.8 MAX Mode Operation

While in MAX mode, the highest detected count rate (since MAX mode was selected) is displayed. The word MAX will be displayed when in MAX mode. A short press of the UNITS button will switch the displayed value between the Primary and Secondary Units.

A short press of the AUDIO button will toggle click audio between Off and On (Hi). When Sigma Audio is enabled, a short press of the AUDIO button will toggle the Sigma Audio volume levels.

Under a non-alarm or alarm condition, a long press of the ON/OFF button will reset the display. When Sigma Audio is enabled, the Sigma Audio alarm level cannot be reset in Max Mode.

If an alarm condition is present, a short press of the ON/OFF button will acknowledge and turn off the alarm audio. Under an alarm condition, the ALARM display indicator will be activated. There are two user settable alarms for both the primary and secondary units. If both alarms for a particular unit are set, the first alarm will activate beeping alarm audio and a flashing ALARM display indicator; If only one alarm is set or the second alarm is triggered, both the alarm audio and the ALARM display indicator are continuous. Alarms are latching in MAX Mode. Under an alarm condition, the ALARM display indicator will remain on until the display is reset.

If other operational modes are available, a short press of the MODE button will move to the next available operational mode. By default, a short press of the LOG button, if datalogging is enabled, will log the currently displayed MAX value.

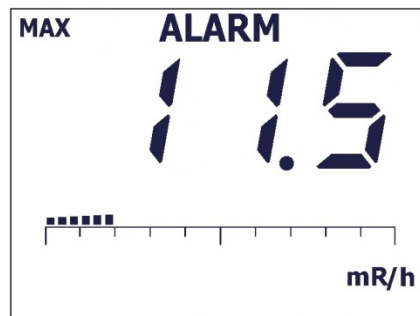

Figure 2.9: MAX Mode Display With ALARM Indication

## 2.9 COUNT Mode Operation

When entering COUNT Mode from another operational mode, the currently selected COUNT Unit will be displayed for approximately one second. The purpose of COUNT mode is to count for a predetermined amount of time, and to display the results on the display. Predefined count times of 6 seconds, 30 seconds, 1 minute, 2 minutes, 5 minutes, and 10 minutes are available as well as a user-defined count time and continuous counting operation (count time displayed as 0 or the minimum display). The maximum user-defined count time is 600 seconds or 10 minutes (9:60). The maximum displayable value, regardless of units, is 999 k.

Count mode operation is very flexible, depending on the units chosen. A common choice is

for the count mode to just perform a scaler count for a specified time, with a resulting answer in counts (equaling detected radiation events).

There are three different options for COUNT mode, which can be set through software.

Go to “Cnt Display Mode” in the Dev tab. Select the desired option:

- **Timer:** Will only show the countdown timer while the timer is active (default selection).
- **Readings:** Will only show the current gathered reading.
- **Timer/Readings:** Will cycle between showing the countdown timer and the current reading.



By default, a short press of the LOG button will start a count and automatically log the result if datalogging is enabled. An extra-long press of the UNITS button during the count will toggle the display between the timer and reading.

Sigma audio is completely disabled in Count Mode. Audio ‘clicks’ are disabled in COUNT mode by default but may be enabled thru software (see Lumatic 2.0 software parameter Dev-Cnt-Audio Mode). Adjusting Dev Cnt Audio Mode will enable or disable the click audio during a COUNT.

- Off - always off
- On - always on
- W/Count - audio is only enabled during an active count



If a result in terms of activity is desired, the scaler count can also be in units of "d" or disintegrations. But if the count units are chosen to be cpm or cps, then the resulting answer is an averaged count rate over the time interval. Similarly, if count units of Bq or dpm are chosen, the resulting answer is an averaged disintegration rate.



If the user desires the instrument to show results in terms of disintegrations/area (eg. dpm/100 cm<sup>2</sup>), then the instrument should be configured for dpm and the appropriate factor should be placed in the Efficiency parameter.

Other choices are to have count mode units of R/h or Sv/h, in which case the COUNT mode result is an averaged exposure or dose rate. But if count mode units of R or Sv are chosen, the

result is shown in accumulated exposure or accumulated dose over the chosen count time. The following tables lists the possibilities:

UNITS	RESULT
c	counts per count time
d	disintegrations per count time
cpm, cps	count rate averaged over the count time
dpm, Bq	disintegration rate, averaged over the count time
R/h, Sv/h	exposure or dose rate, averaged over the count time
R, Sv	integrated exposure or dose over the count time

Table 2.1: COUNT Mode Units and Result

In COUNT mode, operation depends on the current state of the Count Timer.

#### When the Count Timer is Ready:

- The display will show the Count Time.
- A short press of the UNITS button will switch between the Primary and Secondary Count Units. The newly selected Count Units will be displayed for approximately one second, and the display will then return to the Count Timer.
- A long press of the ON/OFF will initiate a count but will not log the results upon completion.
- An extra-long press of the UNITS button will change the count time to the next available time.
- Pressing and holding the UNITS button will also change the count time to the next available time but will scroll through all possible count times at approximately one-second intervals.
- If other operational modes are available, a short press of the MODE button will move to the next available operational mode.
- By default, a short press of the LOG button will initiate a count and log the displayed result upon completion, if datalogging is enabled.

#### When the Count Timer is Active:

- The display will show either Count Time (default), both Count Time and Counts, or just Counts, depending on Device Count Display Mode.
- If needed, a long press of the ON/OFF button will stop the count and reset the Count Timer (results will not be logged if previously requested).
- Click audio, if enabled, can be adjusted by a short press of the AUDIO button.

- If an alarm condition occurs, the ALARM display indicator will turn on, and the Alarm audio will sound as soon as the count is complete. (If the count unit is an averaged rate, it is possible for the ALARM icon to come on during the count, but if the averaged rate falls below the alarm threshold by the end of the count, no ALARM will be active.)
- If other operational modes are available, a short press of the MODE button will cancel the current Count Timer and move to the next available operational mode.
- By default, the LOG button is unused during a count.

**When the Count Timer has Finished:**

- The display will show either the accumulated total for c, d, R, and Sv, or the timed ratemeter average for cps, cpm, dpm, or the average exposure or average dose in R/h and Sv/h.
- If datalogging is enabled and logging the count results was previously requested, the results will be logged to the log buffer.
- A short press of the UNITS button will switch between the Primary and Secondary Count Units.
- a long press of the ON/OFF button will reset the Count Timer and initialize for a new count.
- If an alarm condition occurred during the Timed Count, a continuous audio tone will sound as the ALARM display indicator will already be on. To acknowledge and turn off the continuous tone alarm audio, a short press of the ON/OFF button is required. To clear the alarm condition and reset the Count Timer, a long press of the ON/OFF button is required.
- If other operational modes are available, a short press of the MODE button will move to the next available operational mode.
- By default, a short press of the LOG button will log the current display.

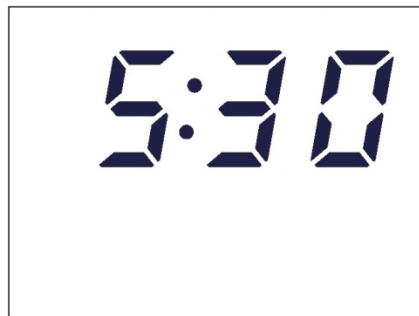

Figure 2.10: COUNT Mode Displaying COUNT Timer of 5 Minutes, 30 Seconds

## SPECIFICATIONS

**Detector:** Internal CsI scintillator

**Sensitivity:** 175 cpm per  $\mu\text{R/hr}$

**Energy Response:** Non-linear (see graphs A.1)

**Detector Range:** 0.001 to 500  $\mu\text{Sv/h}$  (0.1  $\mu$  to 50 mR/hr)

**HV Range:** 400-1500 Vdc

**Threshold Range:** -20 to -100 mVdc

**Linearity:** readings within 10% of true value

**Resolving Time:** approximately 5  $\mu\text{sec}$  as defined by IEC 60325

**Response Time:** user-selectable from 1 to 60 seconds, auto-response rate of fast or slow

**Alarms:** two adjustable count rate, exposure/dose, and count alarm setpoints adjustable over the display range

**Overload Protection:** high count rate saturation protection designed to prevent the false display of lower count rates

**Loss of Count Protection:** after a user-settable number of seconds, typically 60 seconds, of no pulses from the detector, the alarm audio will be triggered

**Dead Time Correction:** employs first and second order corrections for extended performance

**Overrange:** if the reading should exceed the predefined detector range, the instrument will flash a maximum reading and trigger an audio warning

**LCD Display:** 3-digit LCD with large 20 mm (0.8 in.) digits, (k)cps, (k)cpm, (k)Bq, (k)dpm, ( $\mu$ )(m)R(/h), ( $\mu$ )(m)Sv(/h), low-battery indicator, MAX, ALARM, AUDIO

**Backlight:** built-in ambient light sensor automatically activates low-power LED backlight or backlight level may be user defined, unless internal dip switch is set to continuous-on

(will reduce battery life)

**User Controls:**

- ON/OFF – extra-long press to turn ON, short press to acknowledge alarms, extra-long press plus 3 seconds to turn OFF
- UNITS – short press changes the units between count rate, dose/exposure, or disintegration, an extra long press to change count time in COUNT mode
- AUDIO - short press to adjust audio level
- MODE – short press alternates between available modes: RATE (displays count rate), MAX (captures peak rate), and COUNT (captures rate or dose readings for a user-selectable count time from 0 to 10 minutes)
- LOG - short press to log current display (or initiate count in COUNT mode)

**Audio:** approximately 4.5 kHz, click audio greater than 65 dB at 0.6 m (2 ft), alarm audio greater than 72 dB

**Headphone Jack (optional):** 1/8 inch stereo jack for use with headphones for audio output. It will be located to the left of the instrument handle.

**Power:** four alkaline “AA” batteries

**Battery Life:** approximately 750 hours (as low as 100 hours w/backlight always on) of operation, 16-hour low-battery warning

**Maximum Current:** 30 mAdc

**Construction:** high-impact plastic with water-resistant rubber seals and separate battery compartment

**Temperature Range:** -20 to 50 °C (-5 to 122 °F), may be certified for operation from -40 to 65 °C (-40 to 150 °F)

**Environmental Rating:** NEMA (National Electrical Manufacturers Association) rating of 5 or IP (Ingress Protection) rating of 53

**Size:** 16.5 x 11.4 x 21.6 cm (6.5 x 4.5 x 8.5 in.) (H x W x L)

**Weight:** 1.06 kg (2.3 lb)

## SETUP MODE



Only advanced users or administrators should consider changing any of the parameters in the following section. Incorrect settings could jeopardize the safety of users depending on this instrument.

### 4.1 Setup Overview

Your instrument has been shipped from Ludlum Measurements only after passing electronic checkout, a 24-hour burn-in process, and a careful calibration process. Calibration papers are supplied with each instrument shipped from Ludlum Measurements.

Recalibration should be accomplished after a predetermined calibration frequency (Ludlum Measurements, Inc. recommends no more than a one-year interval), or when the operation of the instrument is suspect or maintenance has been performed on the instrument. Recalibration is not normally required following instrument cleaning or battery replacement. While recalibration does not require any special tools or software to perform, Lumatic software available through Ludlum Measurements, Inc. will greatly ease calibration, especially when second-order deadtime correction (extended calibration) is being utilized. As a result, the use of Lumatic software is highly recommended.

Ludlum Measurements offers a full-service repair and calibration department. Not only do we repair and calibrate our own instruments, we also service most other manufacturers' instruments. Calibration procedures are available upon request for customers who choose to calibrate their own instruments.



Ludlum Measurements, Inc. recommends recalibration at intervals no greater than one year, assuming that regular operational checks are performed. Check the appropriate local, state, and federal regulations to determine required recalibration intervals.

## 4.2 Setup Parameters

Setting	Setup Parameter	Default Value	Notes
P1-1	Calibration Constant Mantissa	110	
P1-2	Calibration Constant Exponent	08	
P1-3	Dead Time Correction 1	50	μsec
P1-4	Dead Time Correction 2 Mantissa	0	
P1-5	Dead Time Correction 2 Exponent	0	
P1-6	Efficiency	15.0	%
P1-7	High Voltage Set Point	800	volts
P1-8	Discriminator Threshold	35	millivolts
P1-9	Detector Current Overload Threshold	100	
P1-10	Loss of Count Alarm Time	60	
P2-1	Unit 1 - Units and Minimum Display	000 μR/h	
P2-2	Unit 1 - Units Maximum Display	50.0 mR/h	
P2-3	Unit 1 - RATE/ MAX Mode Alarm 1	2.00 mR/h	
P2-4	Unit 1 - RATE/ MAX Mode Alarm 2	5.00 mR/h	
P2-5	Unit 1 - Count Units and Minimum Display	0.00 μR	
P2-6	Unit 1 - Count Units Alarm 1	000	Disabled
P2-7	Unit 1 - Count Units Alarm 2	000	Disabled
P3-1	Unit 2 - Units Minimum Display	000 cpm	Non-SI exposure rate
P3-2	Unit 2 - Units Maximum Display	999 kcpm	
P3-3	Unit 2 - RATE/ MAX Mode Alarm 1	000	Disabled
P3-4	Unit 2 - RATE/ MAX Mode Alarm 2	000	Disabled
P3-5	Unit 2 - Count Units and Minimum Display	000 c	Non-SI exposure



Setting	Setup Parameter	Default Value	Notes
P3-6	Unit 2 - Count Units Alarm 1	000	Disabled
P3-7	Unit 2 - Count Units Alarm 2	000	Disabled
P4-1	Response Time	0	Enable Auto Response
P4-2	Response Rate	S	Slow Auto Response
P4-3	Enabled Modes	0	All Modes Available
P4-4	Count Time	1	second
P4-5	Auto Shutdown Time	0	Hours (Disabled)
P4-6	Backlight Threshold	LO	Most Sensitive
P4-7	Sigma Audio Mode	ON	Enabled
P5-1	Datalogging Mode	1	Mode 1
P5-2	Real Time Clock Month	1	
P5-3	Real Time Clock Day	7	
P5-4	Real Time Clock Year	14	2014
P5-5	Real Time Clock Hour	16	24 Hour Mode
P5-6	Real Time Clock Minute	30	
P5-7	Real Time Clock Second	00	

Table 4.1: Setup Parameters

## 4.3 Entering Setup Mode

To enter Setup Mode, power down the Model 3019 then turn the unit back ON. When the instrument has begun normal operation, three short presses of the MODE button will place the instrument into Setup mode.



This process is different if you are in Sigma Audio Mode, rather than in the “click” Audio Mode. While trying to enter Setup Mode with Sigma Mode enabled, once the screen begins the Sigma countdown, press the Mode button three times. Do not wait until the countdown is complete, which will prevent you from getting into the Setup Mode. There is no countdown for the “click” Audio Mode.

Entry to Setup Mode can be confirmed when the numeric portion of the display shows P-1, indicating the first setup page is selected. If you simply wish to view the parameters, select the desired Setup Page by a short press of the MODE button. A short press of the UNITS button will advance through the parameters available on the selected Setup Page. To return to normal operation, advance back to the Setup Page selection by pressing the UNITS button

for at least a half second. Pressing the UNITS for at least a half second again will exit, or holding the UNITS button for approximately 5 seconds will exit from anywhere in the menu.



If the menu is not exited properly, any changes made will not be saved.

**SETUP PROTECT:** By default, the Model 3019 is shipped with DIP Switch 2 in the OFF (back) position and all available Model 3019 parameters may be modified in Setup mode. To protect the Model 3019 from changes in Setup mode, open the instrument, by removing the six screws on the bottom of the can, and slide DIP Switch 2 (the rightmost switch) to the ON (forward) position to activate Setup Protect Mode.



The dipswitch has a plastic cover, which protects the switch during manufacturing. This plastic cover is left on the dipswitch after assembly and is not removed until the dipswitch is needed. If the plastic cover still remains on the dipswitch, please remove the cover before changing the switch settings.

There are four different options for protect mode, which can be set through the Lumatic 2.0 Calibration Software. Locate the Parameter “Setup Prtct” in the Dev tab and select the desired option.

- **Normal:** All parameters are protected from change through the device menu. This is the default mode when the Setup Protect dipswitch is configured to the ON position.

- **Bypass Alarms:** All parameters except for Rate, Count, and Dose Alarms are protected from change through the device menu.

- **Bypass Alarms Count:** All parameters except for Rate Alarms, Count Alarms, Dose Alarms, and the User Defined Scaler Count Time are protected from change through the device menu.

- **Bypass All:** All parameters may be changed from the Setup Menu, similar to leaving the Setup Protect DIP Switch set to the OFF position.



With the DIP Switch 2 in the ON position, setup mode may be entered through the front panel, and any parameter which has not been bypassed may be viewed, but changes cannot be made. Only bypassed parameters may be changed.

**DISPLAY BACKLIGHT ‘Continuous On’:** The Model 3019 display backlight can be set to remain on continuously during operation. Follow the steps from **SETUP PROTECT** to access the DIP switch but change DIP Switch 1 for display backlight selection. Setting DIP Switch 1 to the ON (forward) position will configure the display backlight to remain on during operation. Set DIP Switch 1 to the OFF (back) position, and the display will be backlit only when

light levels are low.



Setting the display backlight for continuous-on operation can result in reduced battery life. The backlight can be configured to always be off as well through the device menu or Lumatic 2.0 Calibration Software.

## 4.4 Setup Mode Operation

Once the Model 3019 is in Setup mode, setup page selection will be displayed on the LCD and the Page number will be blinking indicating it as the selected item. The number of available parameters per Setup Page will be displayed using the graph where the number of segments indicates the number of parameters. Short press the MODE button to choose the Setup Page you are interested in. Once the desired Setup Page is shown, short press the UNIT button to cycle down to the first parameter of that Setup Page. Further short presses on the MODE button will cycle down through the parameters for that page. Extra-long-pressing the UNIT button will go back up to the Setup Page. Extra-long pressing again will exit the Setup Mode.



Figure 4.1: Setup Page Selection Display (showing page 4-CAL)

To exit more quickly, press and hold the UNIT button. No matter what parameter is shown, it will walk the user through all previous Setup Menu levels until the instrument returns to normal operation. Changed parameters are only saved when exiting the Setup Menu using the UNITS button.

When you get to a parameter that you want to change, use the MODE button to make the change. If numbers are displayed on the parameter, the MODE button will increment the numbers. Otherwise, the MODE button will cycle through the available settings. If more than one parameter can be changed on the page, short press the ON/OFF button to advance through the available parameters, and then use the MODE to change the parameter. When you have adjusted the parameter setting to your desired number or setting, extra-long press the UNIT button to return to the previous screen.

### For example:

#### Rate Mode, Unit 1, Alarm 1 Value to 150 mR/h.

Enter the Setup Menu.

- Use the MODE button to advance to P-2.

- Press the UNIT button to enter the menu.
- Press the UNIT button to get to the third of the seven menu items. This is the parameter setting for the “Unit 1 RATE/MAX Mode Alarm 1.”
- Press the ON/OFF button to advance to the tens digit.
- Press the MODE button to increment the value to 5.
- Press the ON/OFF button to advance to the hundreds digit.
- Press the MODE button to increment the value to 1.
- Press the ON/OFF button to advance to the decimal point.
- Press the MODE button to until no decimal is displayed.
- Press the ON/OFF button to advance to the multiplier.
- Press the MODE button to until mR/h is displayed.
- Press and hold the UNIT button until the instrument returns to normal operation.

The list below shows the setup pages and the parameters in order, on each page.

## 4.5 Model 3019 List of Parameters (in order)

Page 1

- Calibration Constant Mantissa
- Calibration Constant Exponent
- Dead Time Correction 1
- Dead Time Correction 2 Mantissa
- Dead Time Correction 2 Exponent
- Efficiency
- High Voltage Setting
- Pulse Threshold
- Detector Current Overload Threshold
- Loss of Count Alarm Time

Page 2

- Primary Units and Minimum Display
- Primary Units Maximum Display
- Primary Units RATE/MAX Mode Alarm 1
- Primary Units RATE/MAX Mode Alarm 2
- Primary COUNT Units and Minimum Display
- Primary COUNT Mode Alarm 1
- Primary COUNT Mode Alarm 2

Page 3

- Secondary Units and Minimum Display
- Secondary Units Maximum Display
- Secondary Units RATE/MAX Mode Alarm 1
- Secondary Units RATE/MAX Mode Alarm 2
- Secondary COUNT Units and Minimum Display
- Secondary COUNT Mode Alarm 1
- Secondary COUNT Mode Alarm 2

Page 4

- Response Time
- Auto Response Rate
- Operational Modes
- COUNT Time
- Auto Shutdown Time
- Backlight Threshold
- Sigma Audio

Page 5

- Datalogging Mode
- Real Time Clock Month

- Real Time Clock Day
- Real Time Clock Year
- Real Time Clock Hour
- Real Time Clock Minute
- Real Time Clock Second



Parameters on Page 5 are not user editable using the instrument Setup Mode. To edit these parameters, please use the Ludlum Lumic Calibration or Lumic Datalogging Software.

## 4.6 Setup Page 1

**Calibration Constant Mantissa** - A short press of ON/OFF to select the value to adjust, and MODE to adjust the value. Value is used with Calibration Constant Exponent to express counts per R. Available values are:

- Ones Place (0-9)
- Tens Place (0-9)
- Hundreds Place (0-9)

**Calibration Constant Exponent** - A short press of ON/OFF to select the value to adjust, and MODE to adjust the value. Value is used with Calibration Constant Mantissa to express counts per R. Available values are:

- Ones Place (0-9)
- Tens Place (0-9)

**Dead Time Correction 1** - A short press of ON/OFF to select the value to adjust, and MODE to adjust the value. Value is in microseconds. Value should be set to zero when checking instrument with a pulser or function generator; otherwise, higher count rates will result in non-linearities. Available values are:

- Ones Place (0-9)
- Tens Place (0-9)
- Hundreds Place (0-9)

**Dead Time Correction 2 Mantissa** - A short press of ON/OFF to select the value to adjust, and MODE to adjust the value. Available values are:

- Ones Place (0-9)
- Tens Place (0-9)
- Hundreds Place (0-9)

**Dead Time Correction 2 Exponent** - A short press of ON/OFF to select the value to adjust, and MODE to adjust the value. Available values are:

- Value between -6 and -12 inclusive

**Channel 1 – Efficiency** - A short press of ON/OFF to select the value to adjust, and MODE to adjust the value. Available values are:

- Ones Place (0-9)
- Tens Place (0-9)
- Hundreds Place (0-9)
- Number of Decimal Places (0 or 1)

Normally the efficiency is used on a per detector basis or 4pi basis, i.e. the efficiency of the detector is calculated by dividing the count rate received from a source by the total disintegration rate of the source. When either dpm or Bq units are chosen, the use of the 4pi efficiency allows the display of the source size or activity on the Model 3019 display.

But if the user desires to have the Model 3019 show results in terms of dpm/100 cm<sup>2</sup>, the user could manipulate the efficiency to produce this result by multiplying the efficiency times the ratio of the detector area to 100 cm<sup>2</sup>. For example, using a detector with an area of 15 cm<sup>2</sup>, if we start with 10% efficiency to measure in dpm, then the parameter could be changed to 1.5% to measure in dpm/100 cm<sup>2</sup>.

Or likewise for Bq/cm<sup>2</sup>, efficiency could be calculated as:  $\text{efficiency} = \text{count rate} / \text{disintegration rate} * \text{detector area (in cm}^2\text{)}$ . For example, with the same detector as above with an area of 15 cm<sup>2</sup>, and starting with an efficiency value of 15%, then the parameter could be changed to 225% to measure in Bq/cm<sup>2</sup>.

**High Voltage** - Short press the ON/OFF to select the value to adjust, and MODE to adjust the value. Available values are:

- Ones Place (0-9)

- Tens Place (0-9)
- Hundreds Place (0-9)
- k Multiplier (on/off)

Use the ON/OFF button to select the appropriate parameter, and use the MODE button to scroll through the parameter options.



The k multiplier also activates left-most decimal point. If k multiplier is used, Hundreds Place becomes the Thousands Place, Tens Place becomes the Hundreds Place, and Ones Place becomes the Tens Place.

**Pulser Threshold** - Short press the ON/OFF to select the value to adjust, and MODE to adjust the value. Available values are:

- Ones Place (0-9)
- Tens Place (0-9)
- Hundreds Place (0-9)



Audio is enabled for this parameter only for ease of setting.

**Detector Current Overload Threshold (Default 100)** - Upon entry into Detector Current Overload Threshold, one of the following parameters will be selected (flashing).

- Rightmost Digit (0-9)
- Middle Digit (0-9)
- Leftmost digit (0-9)
- $\mu$ /m/<> Multiplier with all digits flashing (adjustable from x.xx  $\mu$  to x.xx)

Perform an extra-long press of the AUDIO button to view the live current draw of the active detector. Performing an extra-long press of the AUDIO button again will return to the set point value.

**Loss of Count Alarm Time** - Upon entry into Channel 1 Loss of Count Time, one of the following parameters will be selected (flashing). Short press the ON/OFF to select the value to adjust, and MODE to adjust the value. Available values are:



- Ones Place (0-9)
- Tens Place (0-9)
- Hundreds Place (0-9)

## 4.7 Setup Page 2

**Primary RATE/MAX Units and Minimum Display** - A short press of the ON/OFF to select the value to adjust, and MODE to adjust the value. Available values are:

- Number of Decimal Places (0, 1, or 2)
- Minimum Units - See List Below

cpm	kcpm	cps	kcps	dpm	kdpm	Bq
kBq	μR/h	mR/h	R/h	μSv/h	mSv/h	Sv/h

Table 4.2: Primary Units and Multipliers

**Primary Units RATE/MAX Maximum Display** - A short press of ON/OFF to select the value to adjust, and MODE to adjust the value. Units will be the same as selected earlier with Primary Units. Available values are:

- Ones Place (0-9)
- Tens Place (0-9)
- Hundreds Place (0-9)
- Number of Decimal Places (0, 1, or 2)
- Range (k on/off for cpm, cps, dpm, Bq; μ, m or none for R/h and Sv/h)

**Primary Units RATE/MAX Mode Alarm 1** - A short press of ON/OFF to select the value to adjust, and MODE to adjust the value. Units will be the same as selected earlier with Primary Units. The ALARM LCD Segment will flash to indicate Alarm 1. Set this Alarm to 000 to disable. Available values are:

- Ones Place (0-9)
- Tens Place (0-9)
- Hundreds Place (0-9)
- Number of Decimal Places (0, 1, or 2)
- Range (k on/off for cpm, cps, dpm, Bq; μ, m or none for R/h and Sv/h)



If the Primary Units has changed to a value other than that used to previously set this Alarm Point, the Alarm Point will be reset to 000.

**Primary Units RATE/MAX Mode Alarm 2** - A short press of ON/OFF to select the value to adjust, and MODE to adjust the value. Units will be the same as selected earlier with Primary Units. The ALARM LCD Segment will remain solid to indicate Alarm 2. Set this Alarm to 000 to disable. Available values are:

- Ones Place (0-9)
- Tens Place (0-9)
- Hundreds Place (0-9)
- Number of Decimal Places (0, 1, or 2)
- Range (k on/off for cpm, cps, dpm, Bq;  $\mu$ , m or none for R/h and Sv/h)



If the Primary Units has changed to a value other than that used to previously set this Alarm Point, the Alarm Point will be reset to 000.

**Primary Count Units and Minimum Display** - A short press of ON/OFF to select the value to adjust, and MODE to adjust the value. Available vallues are:

- Number of Decimal Places (0, 1, or 2)
- Minimum Units depend on the selected Primary Units. See list below.

Primary Units	Primary Count Units Available
cps kcps	cps c
cpm kcpm	cpm c
Bq kBq	Bq d
dpm kdpm	dpm d
$\mu$ R/h mR/h R/h	$\mu$ R/h mR/h R/h $\mu$ R mR R
$\mu$ Sv/h mSv/h Sv/h	$\mu$ Sv/h mSv/h Sv/h $\mu$ Sv mSv Sv

Table 4.3: Primary Unit Multipliers

**Primary Units COUNT Mode Alarm 1** - A short press of ON/OFF to select the value to adjust, and MODE to adjust the value. Units will be the same as selected earlier with Primary Count Units. The ALARM LCD Segment will flash to indicate Alarm 1. Set this Alarm to 000 to disable. Available values are:

- Ones Place (0-9)

- Tens Place (0-9)
- Hundreds Place (0-9)
- Number of Decimal Places (0, 1, or 2)
- Range (k on/off for cpm, cps, dpm, Bq;  $\mu$ , m or none for R/h and Sv/h)



If the Primary Count Units has changed to a value other than that used to previously set this Alarm Point, the Alarm Point will be reset to 000.

**Primary Units COUNT Mode Alarm 2** - A short press of ON/OFF to select the value to adjust, and MODE to adjust the value. Units will be the same as selected earlier with Primary Count Units. The ALARM LCD Segment will remain solid to indicate Alarm 2. Set this Alarm to 000 to disable. Available values are:

- Ones Place (0-9)
- Tens Place (0-9)
- Hundreds Place (0-9)
- Number of Decimal Places (0, 1, or 2)
- Range (k on/off for cpm, cps, dpm, Bq;  $\mu$ , m or none for R/h and Sv/h)



If the Primary Count Units has changed to a value other than that used to previously set this Alarm Point, the Alarm Point will be reset to 000.

## 4.8 Setup Page 3

**Secondary RATE/MAX Units and Minimum Display** - A short press of the ON/OFF to select the value to adjust, and MODE to adjust the value. Available values are:

- Number of Decimal Places (0, 1, or 2)
- Minimum Units - See List Below

cpm	kcpm	cps	kcps	dpm	kdpm	Bq
kBq	$\mu$ R/h	mR/h	R/h	$\mu$ Sv/h	mSv/h	Sv/h

Table 4.4: Secondary Units and Multipliers

**Secondary Units RATE/MAX Maximum Display** - A short press of ON/OFF to select the value

to adjust, and MODE to adjust the value. Units will be the same as selected earlier with Secondary Units. Available values are:

- Ones Place (0-9)
- Tens Place (0-9)
- Hundreds Place (0-9)
- Number of Decimal Places (0, 1, or 2)
- Range (k on/off for cpm, cps, dpm, Bq;  $\mu$ , m or none for R/h and Sv/h)

**Secondary Units RATE/MAX Mode Alarm 1** - A short press of ON/OFF to select the value to adjust, and MODE to adjust the value. Units will be the same as selected earlier with Secondary Units. The ALARM LCD Segment will flash to indicate Alarm 1. Set this Alarm to 000 to disable. Available values are:

- Ones Place (0-9)
- Tens Place (0-9)
- Hundreds Place (0-9)
- Number of Decimal Places (0, 1, or 2)
- Range (k on/off for cpm, cps, dpm, Bq;  $\mu$ , m or none for R/h and Sv/h)



If the Secondary Units has changed to a value other than that used to previously set this Alarm Point, the Alarm Point will be reset to 000.

**Secondary Units RATE/MAX Mode Alarm 2** - A short press of ON/OFF to select the value to adjust, and MODE to adjust the value. Units will be the same as selected earlier with Secondary Units. The ALARM LCD Segment will remain solid to indicate Alarm 2. Set this Alarm to 000 to disable. Available values are:

- Ones Place (0-9)
- Tens Place (0-9)
- Hundreds Place (0-9)
- Number of Decimal Places (0, 1, or 2)
- Range (k on/off for cpm, cps, dpm, Bq;  $\mu$ , m or none for R/h and Sv/h)



If the Secondary Units has changed to a value other than that used to previously set this Alarm Point, the Alarm Point will be reset to 000.

**Secondary Count Units and Minimum Display** - A short press of ON/OFF to select the value to adjust, and MODE to adjust the value. Available vallues are:

- Number of Decimal Places (0, 1, or 2)
- Minimum Units depend on the selected Secondary Units. See list below.

Secondary Units	Secondary Count Units Available
cps kcps	cps c
cpm kcpm	cpm c
Bq kBq	Bq d
dpm kdpm	dpm d
$\mu$ R/h mR/h R/h	$\mu$ R/h mR/h R/h $\mu$ R mR R
$\mu$ Sv/h mSv/h Sv/h	$\mu$ Sv/h mSv/h Sv/h $\mu$ Sv mSv Sv

Table 4.5: Secondary Unit Multipliers

**Secondary Units COUNT Mode Alarm 1** - A short press of ON/OFF to select the value to adjust, and MODE to adjust the value. Units will be the same as selected earlier with Secondary Count Units. The ALARM LCD Segment will flash to indicate Alarm 1. Set this Alarm to 000 to disable. Available values are:

- Ones Place (0-9)
- Tens Place (0-9)
- Hundreds Place (0-9)
- Number of Decimal Places (0, 1, or 2)
- Range (k on/off for cpm, cps, dpm, Bq;  $\mu$ , m or none for R/h and Sv/h)



If the Secondary Count Units has changed to a value other than that used to previously set this Alarm Point, the Alarm Point will be reset to 000.

**Secondary Units COUNT Mode Alarm 2** - A short press of ON/OFF to select the value to adjust, and MODE to adjust the value. Units will be the same as selected earlier with Secondary Count Units. The ALARM LCD Segment will remain solid to indicate Alarm 2. Set this Alarm to 000 to disable. Available values are:

- Ones Place (0-9)

- Tens Place (0-9)
- Hundreds Place (0-9)
- Number of Decimal Places (0, 1, or 2)
- Range (k on/off for cpm, cps, dpm, Bq;  $\mu$ , m or none for R/h and Sv/h)



If the Secondary Count Units has changed to a value other than that used to previously set this Alarm Point, the Alarm Point will be reset to 000.

## 4.9 Setup Page 4

**Response Time** - A short press of ON/OFF to select the value to be adjusted, and MODE to adjust the value. Setting the Response Time to a fixed value is useful primarily when performing surveys to a fixed MDA (Minimum Detectable Activity) level. Setting the Response Time to 0 will enable the Auto-Response mode for the Model 3019 (see the next parameter). Available values for the Response Time (in seconds) are:

- Ones Place (0-9)
- Tens Place (0-6, 6 forces max Response Time of 60)

**Auto-Response Rate** - A short press of ON/OFF to select Fast (F) or Slow (S). When operating in Auto-Response mode, the Model 3019 will vary the Response Time based on the Auto-Response Rate selected (Fast or Slow) and the current Count Rate. The following table shows the response time for different count rates when these auto response modes are chosen:

Count Rate	Auto Response Time - Fast (Seconds)	Auto Response Time - Slow (Seconds)
Less than 3kcpm (50cps)	10.5	21
Between 3 kcpm and 4 kcpm (67 cps)	8.4	16.8
Between 4 kcpm and 6 kcpm (100 cps)	6.3	12.6
Between 6 kcpm and 12 kcpm (200 cps)	4.2	8.4
More than 12 kcpm	2.1	4.2

Table 4.6: Response Time Based on Count Rate

The Model 3019 also utilizes a Step function in Auto Response mode, which enables faster response to a significant increase or decrease in Count Rate. When the instrument detects a sudden change in count rate from the detector, the response time is reduced to 1 second to quickly show the new value.

**Operational Modes** - A short press of MODE to adjust the value. Available values are:

- 0 - RATE, MAX and COUNT modes
- 1 - RATE and MAX Modes only
- 2 - RATE AND COUNT Modes only
- 3 - RATE Mode only

**Count Time** - A short press of ON/OFF to select the value to be adjusted, and MODE to adjust the value. Setting Count Time to 0 enables continuous count until reset. If 9 minutes are selected, then the maximum seconds value is 60; otherwise, the maximum seconds value is 59. Available values are:

- Ones Place (0-9)
- Tens Place (0-6, 6 only available if minutes value is 9)
- Hundreds Place (0-9)

**Auto Shutdown Time (Default 0 - off)** - A short press of MODE to adjust the value. Available values are:

- Ones Place (0-9) hours

**Backlight Threshold** - A short press of MODE to adjust the value. Available values are:

- LO - Backlight comes on at a higher ambient light level.

There are two different options for Backlight Threshold Low, which can be set through the software. Locate the parameters in the Dev tab. Enter the desired number into the "Value" field.

- Low Light Turn On - This value will set the threshold that the backlight will turn on at. (This should be lower than the Low Light Turn Off value.)
- Low Light Turn Off - This value will set the threshold that the backlight will turn off at. (This should be higher than the Low Light Turn On value).

- HI - Backlight comes on at a lower ambient light level.

There are two different options for Backlight Threshold High, which can be set through the software. Locate the parameters in the Dev tab. Enter the desired number into the "Value" field.

- High Light Turn On - This value will set the threshold that the backlight will turn on at. (This should be lower than the High Light Turn Off value.)
- High Light Turn Off - This value will set the threshold that the backlight will turn off at. (This should be higher than the High Light Turn On value).

- OFF - Disables backlight

**Sigma Audio** - A short press of MODE to adjust the value. Available values are:

- ON - Sigma Audio Enabled
- OFF - Sigma Audio Disabled (Normal 'Click' audio active)



The Sigma Mode may not work properly until the 8-second background is completed. If the 8-second background count is too low or too high, the device will continually beep until an acceptable background count rate (500 cpm - 200 kcpm) is obtained. Sigma Audio is disabled in Count Mode. If Count audio and Sigma Audio are enabled, Count audio will be “click” audio.

## 4.10 Setup Page 5

**Datalogging Mode** - Displays the current Datalogging Mode selection for the device. Valid values are 1 - 3.

**Month** - Displays the month of the Real Time Clock. Valid values are 1 - 12.

**Day** - Displays the day of the Real Time Clock. Valid values are 1 - 31.

**Year** - Displays the decade and year of the Real Time Clock. Valid values are 00 - 99.

**Hour** - Displays the hour of the Real Time Clock. Valid values are 0 - 23.

**Minute** - Displays the minutes of the Real Time Clock. Valid values are 00 - 59.

**Seconds** - Displays the seconds of the Real Time Clock. Valid values are 00 - 59.



## DATALOGGING

The datalogging feature of the Model 3019, accessible through the use of the optional Lumatic Datalogger software kit, allows the user to log radiation readings with the use of a handle-mounted LOG button. Data can be logged in any of the Model 3019's operational modes (RATE, MAX, and COUNT). Up to 1000 data points can be taken and stored internally. Depending on the chosen Datalogging Mode, the user can quickly save logged data using a single Location ID, or select from up to 250 stored Location IDs. A Real Time Clock (RTC) is utilized to time and date stamp each datalog entry.

The saved log data and stored location IDs can be viewed, downloaded, and erased using the LMI Lumatic Datalogger software kit, which includes a USB cable. Editing of datalogging parameters and RTC via setup mode on the instrument is disabled.

Setup of the datalogging parameters is also done through the LMI Lumatic Datalogger software. The advanced user or administrator can set:

- Datalogging Mode
- Real Time Clock (RTC) Values
- Location IDs

### 5.1 Datalogging Operation – Mode 1

Datalogging Mode 1 will store the logged data using only the first Location ID in the Location ID table.

- When the LOG button is pressed, the current radiation reading and other log data is saved along with the first Location ID in the format specified in the Specifications at the end of this section.
- In COUNT Mode:
  - During a count, the LOG button is disabled until completion of a Scaler count.

- For a continuous Scaler count (Scaler time is 0), the LOG button is enabled at all times.
- For approximately 2 seconds, the LCD will display the Datalog Table index for the newly saved log data.



Figure 5.1: Displaying Datalog Table Index of 12

- After displaying the Datalog Table index, the instrument will return to the previous mode of operation.
- The Datalog Table is linear; once the table is full, no further writes will be allowed until the Datalog Table is erased.
- If an attempt is made to write to a full Datalog Table, several 1/4 second audio alerts will sound and the maximum Datalog Table index (1.00 k) will be displayed for about 2 seconds. The instrument will then return to the previous mode of operation.

## 5.2 Datalogging Operation – Mode 2

Datalogging Mode 2 will allow the user to choose the Location ID (by Location ID Table index) to store with the logged data.

- When the LOG button is pressed, the current radiation readings and other log data are temporarily stored.
- In COUNT Mode:
  - By default, Mode 2 is disabled during a count; instead, the datalogging feature functions as it would in Mode 1.
- The LCD display will show a possible Location ID Table index for the user. The index will be auto-incremented from the previously used index.



Figure 5.2: Displaying Datalog Location ID Table Index of 36

- The number will be blinking, indicating a changeable value. The user may then enter the preferred Location ID Table index by a short press of the MODE (to increment the value) as in Setup mode.
- Once the user has the preferred Location ID Table index entered, a short press of the LOG button will save the log data.
- After displaying the Datalog Table index, the instrument will return to the previous mode of operation.
- The Datalog Table is linear; once the table is full, several 1/4 second audio alerts will sound and the maximum Datalog Table index (1.00 k) will be displayed for about 2 seconds, and no further writes will be allowed until the Datalog Table is erased.

### 5.3 Datalogging Operation – Mode 3

Datalogging Mode 3 will automatically record data log records using the current location saved in Location Mode 3 with the user settable auto log interval, Mode 3 Timer, settable to record every 1 to 1800 seconds.

- When the Device is turned on and in RATE or MAX mode, the current radiation reading and other log data is recorded at the set interval.
- In SCALER Mode:
  - Auto log will be paused and will only log at the completion of each count.
  - For a continuous Scaler count (Scaler time is 0), logs will be recorded at auto log interval.
- No visual indication will occur.
- The Datalog Table is linear; once the table is full, a 1/4 second audio alert will sound at the autolog interval, and no further writes will be allowed until the Datalog Table is erased.



When connecting to Lumic 2 software or Lumic Data Logging software while the instrument is logging in Mode 3, the instrument may disable data logging to prevent conflicts from occurring while both reading and writing to the data log buffer. While this will be immediately reported when reading from the instrument, this will not be immediately noticed when pulling the data log records from the instrument. Always read from the instrument and check the status of 'Is Logging Enabled' using the Data Logging Software before exiting the software to ensure your instrument is functioning properly.



A short press of the LOG button will start a count and automatically log the result. An extra-long press of the UNIT button during the count will toggle the display between the timer and reading.

## 5.4 Data Log Operation

- **LOG Button:** handle-mounted
- **Clock:** Real Time Clock
- **Location ID Storage:** internal storage of up to 250 32-byte location IDs
- **Datalog Record Storage:** internal storage of up to 1000 64-byte datalog records

## 5.5 Format

The datalogging format is as follows:

- Format Version (1 Byte)
- Month (1 Byte)
- Year (2 Bytes)
- Day (1 Byte)
- Hour (1 Byte)
- Minutes (1 Byte)
- Seconds (1 Byte)
- Logged Value (4 Bytes)
- Range (1 Byte)
- Units (1 Byte)
- Mode (1 Byte)

- Detector Number (1 Byte)
- Status (1 Byte)
- Reserved (2 Bytes)
- Elapsed Count Time in seconds (4 Bytes)
- Scaler Count Time in seconds (4 Bytes)
- Location ID (32 Bytes)



## SOFTWARE

### 6.1 Connecting to Lumic 2.0 Calibration/Configuration Software

The Lumic 2.0 Calibration/Configuration software is sent with a standard two-meter cable. (A five-meter cable can be provided if requested. However, any cable longer than two meters may have issues with some USB hubs and computers, typically laptops.)

To connect an instrument to the computer, please connect one end of the USB cable to the instrument first, and then the other end to the computer. Do not connect both ends to the computer.

Please allow Windows® a moment to install the proper HID drivers for the instrument before trying to use any software.



We recommend that you plug the USB cable into the back of your PC that connects to your motherboard instead of a USB hub.



Some parameters may only be edited in software, such as the backlight thresholds, COUNT Display Mode, COUNT Audio Mode, and Setup prtct.

Follow the Lumic 2.0 Calibration/Configuration software manual.





## ADVANCED FEATURES

### 7.1 Dead Time Correction

All pulse counting detectors have a “dead time” in which the detector is unable to register another event. In relatively low fields this is not an issue. However, as the field strength approaches the high end of the detector’s range, dead time causes the pulse rate to become non-linear with respect to the real radiation field. Dead time correction is used to linearize the measurements, allowing a wider linear response range for a given detector.

This instrument uses a second order dead time correction using the equation

$$rate_c = rate_m / [1 - (DTC_1 * rate_m) + (DTC_2 * rate_m^2)]$$

Where  $DTC_1$  and  $DTC_2$  are the dead time correction coefficients,  $rate_m$  is the measured count rate, and  $rate_c$  is the corrected rate.

Dead time correction coefficients are configured through the device setup menu or through Lumic Calibration software. Lumic Calibration software also includes a wizard that will automate finding and setting the correct coefficients.

$DTC_1$  is represented in microseconds ( $\mu$ s) on the device setup menu and in the software. The equation must be calculated in terms of seconds (s) and must be scaled appropriately.  $DTC_2$  has more complex units and are not shown. However, the representation of the coefficient on the setup menu and in software do not require scaling.



Setting the  $DTC_2$  to zero will disable the second order correction, while setting  $DTC_1$  to zero will disable both, regardless of the value of  $DTC_2$ .

### 7.2 Units

Depending on the chosen display units, different features will affect the value of the reading. The following table lists the features that apply to each of the display units.

UNITS	Feature
cpm, cps, counts	Deadtime Correction
Bq, dpm, disintegrations	Deadtime Correction, Efficiency
R/h, R	Deadtime Correction, Calibration constant
Sv/h, Sv,	Deadtime Correction, Calibration constant , R to Sv Conversion

Table 7.1: Features That Affect Units in All Modes

### 7.3 R to Sv Conversion

The R to Sv conversion is a setting available in Lumatic Calibration software. It defines the conversion factor between R and Sv. Since the calibration constant is directly tied to R (counts per R), calibrating Sv requires a correct setting of both calibration constant and R to Sv conversion.

Example: An R to Sv conversion factor of 0.0106 will cause a reading of 10.6 mSv/h while in a 1 R/h field.

### 7.4 Software Calibration Tools

Lumatic Calibration software includes wizards that will assist in calibrating and plateauing detectors. After configuring the wizard for a specific detector, the wizard will automate much of the data collection and calculation required for calibration.

### 7.5 Hardware Correction

This instrument provides the user with the ability to manually enter a voltage for both high voltage and threshold. To ensure that the voltage entered by the user produces a proper high voltage or threshold voltage that is within instrument tolerances, the instrument is adjusted at the factory during manufacturing. As a result, adjustment of any parameters visible in the DevCal menu of the Lumatic 2 software is not required and should not be adjusted in the field. However, if hardware correction is required (due to board rework, etc.) the hardware correction settings are available in Lumatic 2 Calibration software on the DevCal tab.

### 7.6 Other Device Data

The following parameters on the instrument allow recording import device information within the device:

**Firmware Version:** This is a read-only presentation of the firmware version. With a firmware version of Ex.y.zzzz, the Ex.y will show up on the device screen during the power-on sequence and signifies the released version.

**Device – Model Name:** This should match the model name on the front face of the instrument.

**Device – Serial Number:** This should match the serial number of the instrument.

**Detector – Model:** This can store the model of the detectors the instrument was calibrated for.

**Detector – Serial Number:** This can store the serial number of the detectors the instrument was calibrated for.

## 7.7 Battery Life

The instrument leaves the shop with adjustments to meet most consumer demands; however, advanced users may use the Lumic software to adjust the LED and backlight brightness to maximize battery life. By changing the backlight mode of operation and adjusting the brightness settings for the backlight and LED to meet user needs, it is possible to reduce battery current consumption by as much as 50%.

## 7.8 Real-time Streaming

Lumic Calibration 2.0 software and this instrument have the ability to stream data from the instrument to a computer. The data can be viewed live inside software or can be recorded in a file.

Multiple user-selected parameters can be streamed simultaneously including:

- Remote display of the screen
- All unit values
- Device status
- Live HV current measurement

## 7.9 Button Mapping

By default, the LOG button's primary purpose is to take a log of the current display or initiate a count, in COUNT mode, and log the result upon completion assuming datalogging is enabled. Lumic Calibration 2.0 software allows the LOG button to be configured (this is referred to as button mapping) to perform a number of features. In some cases, the available features are only useful for a particular function. As a result, the LOG button can be mapped for RATE/MAX modes and COUNT mode separately.

Using the Lumic Calibration 2.0 software, the user can select among the following features, which can be mapped to the short press, long press, and extra-long press of the LOG button.

- Do Nothing - This button press has no effect. This is the default configuration for a long press and an extra-long press of the LOG button.
- Take Log - Log the current display or initiate a count in COUNT mode and log the results upon completion (assuming datalogging is enabled). This is the default configuration for a short press of the LOG button.
- Change Units - Changes to the next available unit. This is similar to a short press of the UNITS button.
- Toggle Click Audio - Changes the audio level. This is similar to a short press of the AUDIO button.
- Change Modes - Changes to the next available mode of operation. This is similar to a short press of the MODE button.
- Toggle Count Display (COUNT mode only) - In COUNT mode, if the count is active, this will switch between the count timer and the count display. This is similar to the extra-long press of the UNITS button in COUNT mode. This has no effect in RATE/MAX modes and should not be used in RATE/MAX button mapping.
- Reset Rate (RATE/MAX mode only) - This will reset the currently displayed rate. This has no effect in COUNT mode.
- Advance Count Mode (COUNT mode only) - In COUNT mode, if the count is ready then the button will initiate a count without logging the results upon completion. If the count is in process, the count will be stopped and the count timer will be reset. If the count has concluded, the count timer will be reset.
- Do Nothing - This button press has no effect. A repeat of the aforementioned 'Do Nothing', this feature supports backwards compatibility with previous versions of firmware previously released with button mapping capability.

## 7.10 CPS Offset

Using the Lumatic Calibration 2.0 software, the user can enter a CPS Offset for a given channel. The CPS Offset is counts per second, which are subtracted from the channel reading's base counts before any dead time correction or unit conversion is applied. This is a useful method by which to perform background subtraction in a controlled environment.



The instrument does not calculate the CPS Offset for the user. The CPS Offset is a fixed value, which must be configured while the instrument is connected to the Lumatic Calibration 2.0 software and which is stored in the instrument and reused each time the instrument is powered on.

By default, CPS Offset is 0 and no count subtraction is performed.

## SAFETY CONSIDERATIONS

### 8.1 Environmental Conditions for Normal Use

Indoor or outdoor use (While rain resistant, user is cautioned to avoid getting water through detector opening.)

No maximum altitude

Temperature range of -20 to 50 °C (-5 to 122 °F), may be certified for operation from -40 to 65 °C (-40 to 150 °F)

Maximum relative humidity of less than 95% (non-condensing)

Pollution Degree 3 (as defined by IEC 664): (Occurs when conductive pollution or dry nonconductive pollution becomes conductive due to condensation. This is typical of industrial or construction sites.)

Not certified for use in an explosive atmosphere

### 8.2 Warning Markings and Symbols



The operator or responsible body is cautioned that the protection provided by the equipment may be impaired if the equipment is used in a manner not specified by Ludlum Measurements, Inc.

The Model 3019 Survey meter is marked with the following symbols:



The “crossed-out wheeie bin” symbol notifies the consumer that the product is not to be mixed with unsorted municipal waste when discarding. Each material must be separated. The symbol is placed on the label located on the side panel. See section 10, “Recycling,” for further information.



The “CE” mark is used to identify this instrument as being acceptable for use within the European Union. This symbol is located on the label on the side panel.



CAUTION (per ISO 3864, No. B.3.1): designates hazardous live voltage and risk of electric shock. During normal use, internal components are hazardous live. This instrument must be isolated or disconnected from the hazardous live voltage before accessing the internal components. This symbol appears on the label on the side panel. Be sure to take the precautions noted in the next section whenever necessary.

### 8.3 Cleaning and Maintenance Precautions

The Model 3019 may be cleaned externally with a damp cloth, using only water as the wetting agent.

Observe the following precautions when cleaning or performing maintenance on the instrument:

- Turn the instrument OFF and remove the batteries.
- Allow the instrument to sit for one minute before cleaning the exterior or accessing any internal components for maintenance.

## REVISION HISTORY



This section of the manual will be updated with each revision of the Model 3019 in order to document changes over time. Ludlum Measurements' policy is to provide for free, the latest firmware release for an instrument for the life of that instrument. Note that not all new firmware features will be available for older instruments due to hardware design changes. If this is the case, it will be noted in the manual.

**December 2013:** New manual.

**May 2014:** Added HV range, Threshold range, and maximum load on supply to Specifications, Section 3.

**July 2014:** Added standard parts list, Section 8. Added note about foam grip in Intro. Added sentence on page 4-6 about setting DTC to zero when checking with pulser.

**September 2014:** In second paragraph on page 4-4, corrected "Mode" button to "Units" button twice. Also changed to hold down button for 4 seconds instead of 3. Updated ON/ACK and AUDIO button operational descriptions to reflect Sigma Audio operation. On page 3-1 changed ON/OFF/Quiet button to ON/OFF/ACK.

**November 2014:** Added a note explaining entering Setup Mode while in Sigma Mode on page 4-3. Added a note on page 4-14 regarding the audio and background.

**December 2015:** Added description of headphone option. Corrected the location of the low-battery indicator. Updated the table on page 4-13. Removed "Units selected as Primary will not be available as Secondary" on page 4-11. Updated Sigma Audio Note on page 4-14.

**April 2016:** Added information about rate reset on page 2-6. Added different options for protect mode to firmware on page 4-3. Took out references to Triad software and replaced with Lumic.

**November 2016:** Added information about the new parameters Backlight Threshold, Device COUNT Display Mode, Device COUNT Audio Mode, and DTC2. Connection information, to most pcs.

**March 2017:** Firmware was updated, which affects Section 2 with more screens at turn-on and changes in what buttons do and how to press/tap them. Updated Audio in Section 3 Specifications. In Section 4 updated Default Values including adding P5 values, added a note on page 4-3 before Setup Protect explanation, added sentence about backlight configuration in note at end of Entering Setup Mode section on page 4-4, detailed types of presses/taps in setting up pages, changed values of Dead Time Correction 2 Exponent (Default 0) to -6 to -12, added Dual Level Audio default at end of Setup page 4. Added Section 5 Datalogging. Section 6 updated to Software with Connecting to Software and Extended Features as sub-sections. Added Section 10 Options.

**October 2017:** Corrected presses/taps where necessary in Sections 2 and 4. Corrected ON/ACK to ON/OFF throughout. Added Auxiliary Communication in Section 2. Replaced the Default Values table on page 4-2 with the Setup Parameters table. Added description of Setup page 5 in Section 4. Added Advanced Features as Section 7.

**October 2018:** Datalogging is no longer an “option” but a standard feature with the logging button as standard on the handle, updated photo on inside cover, added paragraph at end of Section 1, deleted 3000 Series Datalogging Option in Section 11. Updated to two alarms in Section 4. Made corrections to first paragraph of Section 6, under Connecting to Software. Changed part # for unimorph with harness in Section 12 from 8498-542 to 8498-542-01. Updated Drawing 498 x 409K. Removed AuxComm section from Section 2 to and moved it to a dedicated Appendix A where more detail was added. September 2019: Added paragraph about dead time correction to Section 1, page 1-2, also added Dead Time Correction to Section 3 Specs. Updated NEMA rating on page 3-2 from 4x to 5.

**November 2020:** Added Linearity to Specifications, page 3-1.

**March 2021:** Firmware updated to version n34, and this manual covers n34 only, which has only one alarm; all references to two alarms deleted. Updated Setup Protect section in Section 4, starting on page 4-4. On page 5-4 under Datalogging Operation – Mode 3 in second bullet point, changed “SCALER Mode” to “COUNT mode.” Deleted Instrument Calibration section in Section 7, page 7-3, due to redundancy. In Section 12, updated Main Board part # from 5498-440 to 5519-042. In Appendix A Auxiliary Communications, page A-6, deleted Setting 5 Simple Counts.

**April 2021:** Removed Extended Features from Section 6 Software, pages 6-2 and 6-3. Removed AuxComm Mode 5 column in table under Settings on Particular Models on page A-9.

**October 2021:** Separated the manual for the 3006 and 3019 into two manuals. New manual format. Firmware updated to version n41, which re-enables many features not available in n34. Re-wrote Intro with more details. Modified Chapter 2: COUNT Mode Operation to explain predefined count times and proper operation. In Chapter 3: Specifications added reference to Energy Response graphs in the appendix in place of Energy Range; added "two adjustable" and more details to Alarms; removed Sigma; added Overrange; and added LOG to User Controls. Modified Chapter 4: Setup Mode to add primary and secondary rate and second count alarms. Added Bypass All as the fourth option for protect mode on page 30. In Chapter 5: Datalogging on page 47, replaced Specifications with Section 5.4 Data Log Operation and Section 5.5 Format. In Chapter 6: Software, deleted the Extended Features



section. In Chapter 7: Advanced Features on page 53, added Section 7.7 Battery Life, 7.9 Button Mapping, and 7.10 CPS Offset. In Chapter 11: Options, changed part number to Lumeric Calibration Kit from 4498-1018 to 4519-563 and deleted Model 3000 Series Datalogging Option because it is now a part of the instrument and not optional. Added Chapter 12: Standard Parts List.

**December 2021:** Firmware updated to version n42 to address new board designs. Added explanation of feature to identify the board installed in the instrument. Clarified the audio alert, which occurs when the data log buffer is full. Noted that data log enable may become disabled when the instrument is logging in Mode 3 and attempting to communicate with Lumeric software.

**February 2022:** Changed main board part number to newest version in Standard Parts List. Updated Lumeric Calibration Kit part number in Options.

**July 2022:** Made names of software more clear in Chapters 5 and 6 when referencing Lumeric Datalogger software kit and Lumeric 2.0 Calibration/Configuration Software.

**January 2023:** In Chapter 4 Setup Mode, Section 4.4 Setup Mode Operation, updated explanation of how changed parameters are saved.



## RECYCLING

Ludlum Measurements, Inc. supports the recycling of the electronics products it produces for the purpose of protecting the environment and to comply with all regional, national, and international agencies that promote economically and environmentally sustainable recycling systems. To this end, Ludlum Measurements, Inc. strives to supply the consumer of its goods with information regarding reuse and recycling of the many different types of materials used in its products. With many different agencies – public and private – involved in this pursuit, it becomes evident that a myriad of methods can be used in the process of recycling. Therefore, Ludlum Measurements, Inc. does not suggest one particular method over another, but simply desires to inform its consumers of the range of recyclable materials present in its products, so that the user will have flexibility in following all local and federal laws.

The following types of recyclable materials are present in Ludlum Measurements, Inc. electronics products, and should be recycled separately. The list is not all-inclusive, nor does it suggest that all materials are present in each piece of equipment:

Batteries	Glass	Aluminum and Stainless Steel
Circuit Boards	Plastics	Liquid Crystal Display (LCD)

Ludlum Measurements, Inc. products that have been placed on the market after August 13, 2005, have been labeled with a symbol recognized internationally as the “crossed-out wheelie bin,” which notifies the consumer that the product is not to be mixed with unsorted municipal waste when discarding. Each material must be separated. On the instrument, the symbol will be placed on the serial number label located on the side of the instrument.

The symbol appears as such:





## OPTIONS

**Lumic Calibration Kit (part # 4519-865):** The kit includes calibration software plus the cable required for calibration. The software allows users to collect data and read, print, and save device parameters. It allows administrators to adjust device parameters.

**Lumic Datalogging Kit (part # 4498-1019):** The kit includes datalogging software plus the required cable. The software allows users to collect data and read, print, and save device parameters. It allows administrators to adjust device datalogging parameters.

**Headphone Option (part # 4498-555):** This provides the Model 3000 series of instruments with a jack and circuitry required for a standard headphone plug. Ludlum Measurements also offers mono/stereo headphones with volume control.

**Shoulder Strap (part # 4498-868):** This adjustable, padded strap comes with a kit to attach it to a Model 3000 series instrument.

**Protective Storage/Transport Case (part # 2312958):** This is a medium-sized, foam-padded, rugged case that can be secured with a padlock. It is fitted with a manual pressure relieve valve for air transport, providing water and dust-proof protection for sensitive instruments.



## STANDARD PARTS LIST

Part Description	Part Number
Model 3019 Digital Survey Meter	48-4091
Model 3019 Main Board	5519-779
Model 3000 Bezel Assembly	4498-412
Model 3000 Main Keypad Membrane Switch	7498-414
Model 3019 Handle Assembly	4498-607
Model 3000 Battery Holder Modified	7498-458
Model 3000 Unimorph with Harness	8498-542-01
LCD 82 mm x 61.64 mm	7498-417

Table 12.1: Standard Parts List





## ENERGY RESPONSE

### A.1 Model 3019 Energy Response

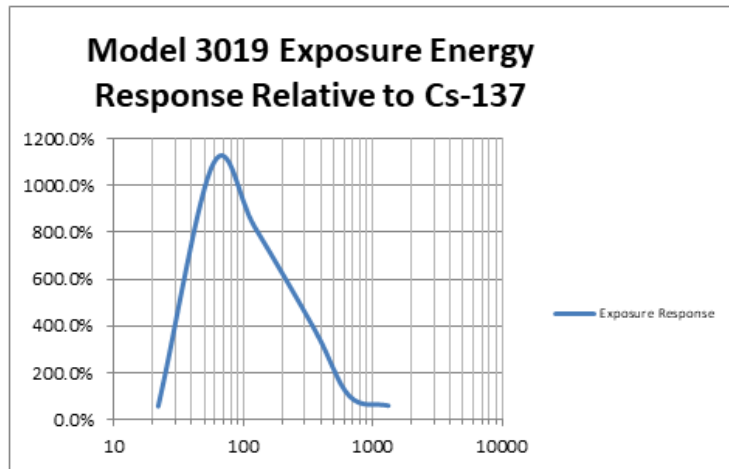

Figure A.1: Model 3019 Exposure

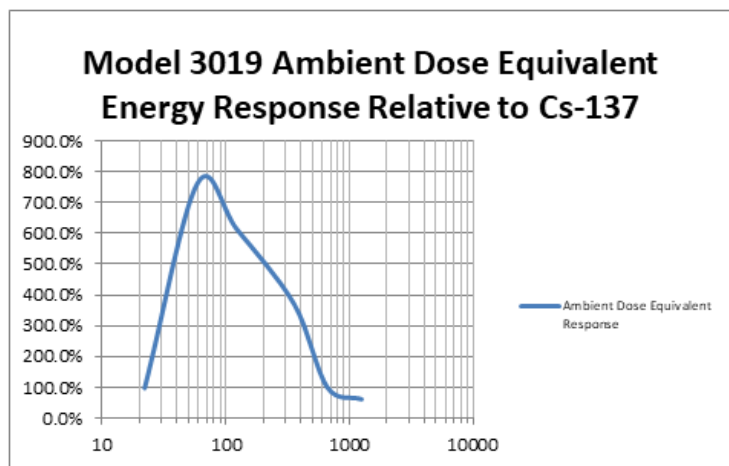

Figure A.2: Model 3019 Ambient Dose