

# **Model 3007i and 3007Bi Neutron Dose Survey Meter**

**Ludlum Measurements**

**March 2024**

**Serial Number: 25022487 and Succeeding**

**Firmware: F.4.0.1120 and Higher**



# Model 3007i and 3007Bi Neutron Dose Survey Meter

Ludlum Measurements

March 2024

Serial Number: 25022487 and Succeeding

Firmware: F4.0.1120 and Higher



**LUDLUM MEASUREMENTS, INC**  
501 OAK STREET, P.O. BOX 810  
SWEETWATER, TEXAS 79556  
325-235-5494, FAX: 325-235-4672



## **STATEMENT OF WARRANTY**

Ludlum Measurements, Inc. warrants the products covered in this manual to be free of defects due to workmanship, material, and design for a period of twelve months from the date of delivery. The calibration of a product is warranted to be within its specified accuracy limits at the time of shipment. In the event of instrument failure, notify Ludlum Measurements to determine if repair, recalibration, or replacement is required.

This warranty excludes the replacement of photomultiplier tubes, G-M and proportional tubes, and scintillation crystals which are broken due to excessive physical abuse or used for purposes other than intended.

There are no warranties, express or implied, including without limitation any implied warranty of merchantability or fitness, which extend beyond the description of the face thereof. If the product does not perform as warranted herein, purchaser's sole remedy shall be repair or replacement, at the option of Ludlum Measurements. In no event will Ludlum Measurements be liable for damages, lost revenue, lost wages, or any other incidental or consequential damages, arising from the purchase, use, or inability to use product.

## **RETURN OF GOODS TO MANUFACTURER**

If equipment needs to be returned to Ludlum Measurements, Inc. for repair or calibration, please send to the address below. All shipments should include documentation containing return shipping address, customer name, telephone number, description of service requested, and all other necessary information. Your cooperation will expedite the return of your equipment.

**LUDLUM MEASUREMENTS, INC.**

**ATTN: REPAIR DEPARTMENT**

**501 OAK STREET**

**SWEETWATER, TX 79556**

**800-622-0828**

**325-235-5494**

**FAX 325-235-4672**



REVISION HISTORY

REV	DESCRIPTION	DATE	BY
1	VALID	1-5-18	CMC

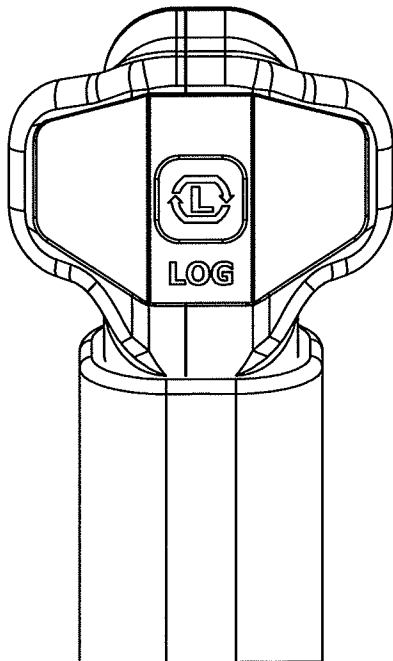
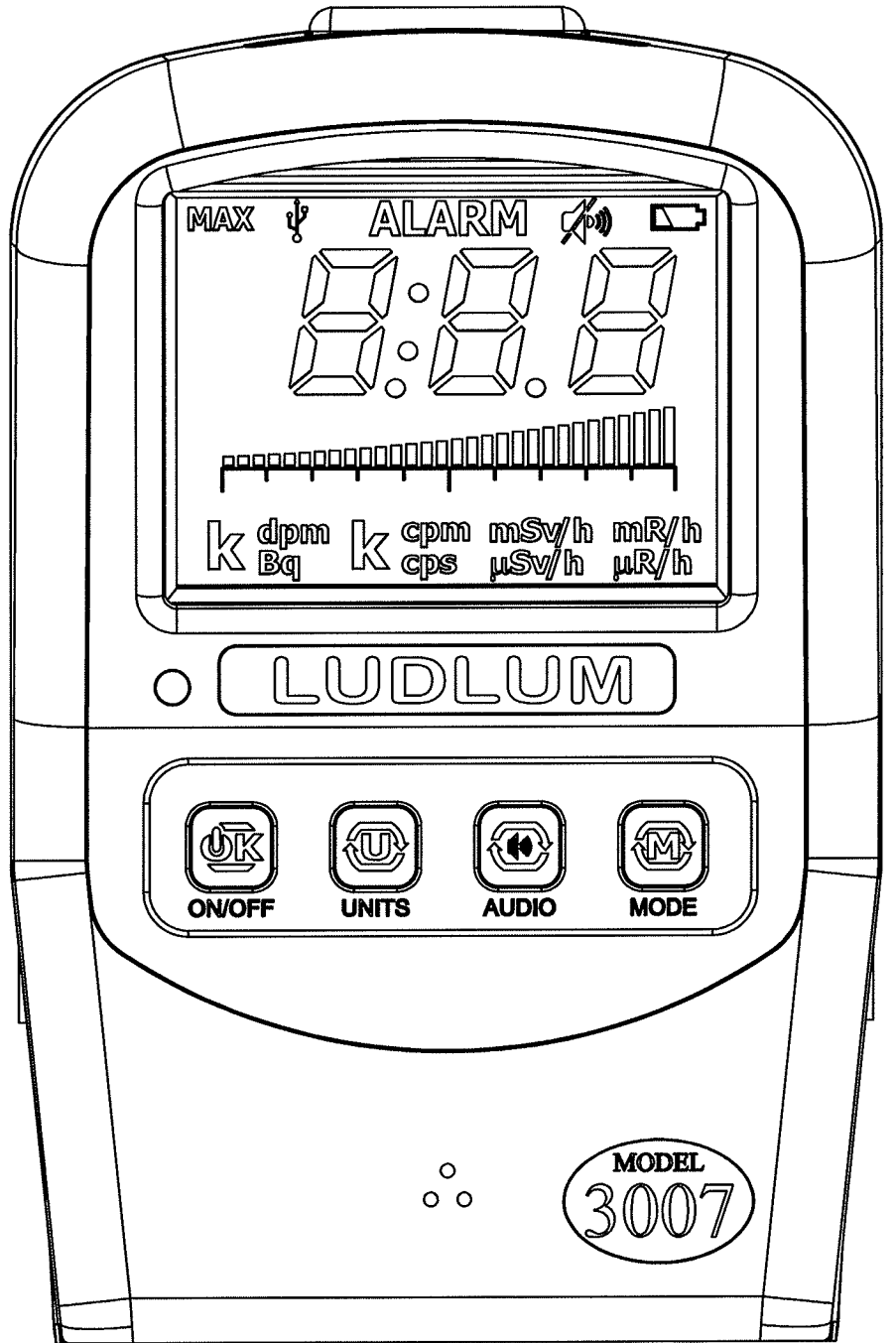

DETAIL B  
SCALE 1 : 1

DETAIL A  
SCALE 1 : 1

DWN	DATE	CHK	DATE	APP	DATE
CMC	1-5-18			<i>slw</i>	1-5-18
<b>DWG NUM: 4519-194</b>				<b>SCALE: 1</b>	
<b>TITLE M 3007 FRONT PANEL</b>					
 LUDLUM MEASUREMENTS, INC. 501 OAK STREET SWEETWATER, TEXAS 79556			SERIES 519	SHEET 194	





REVISION HISTORY			
REV	DESCRIPTION	DATE	BY
1	VALID	1-5-18	CMC

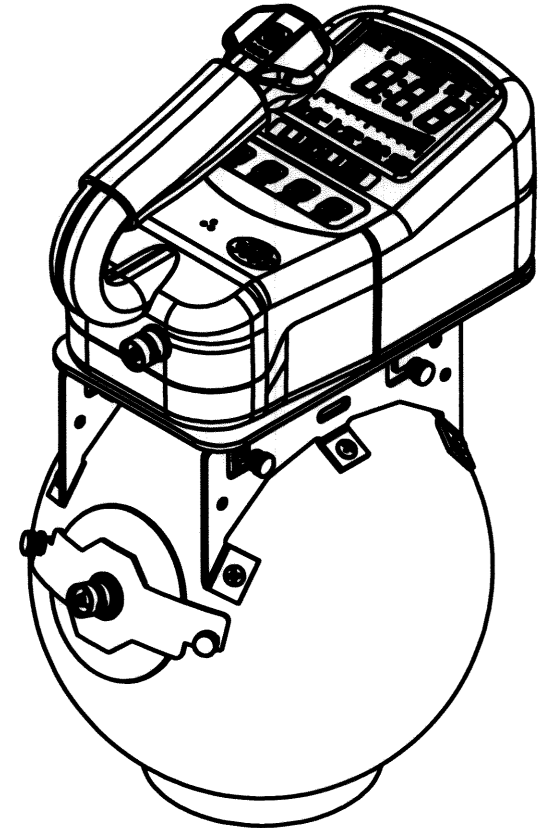
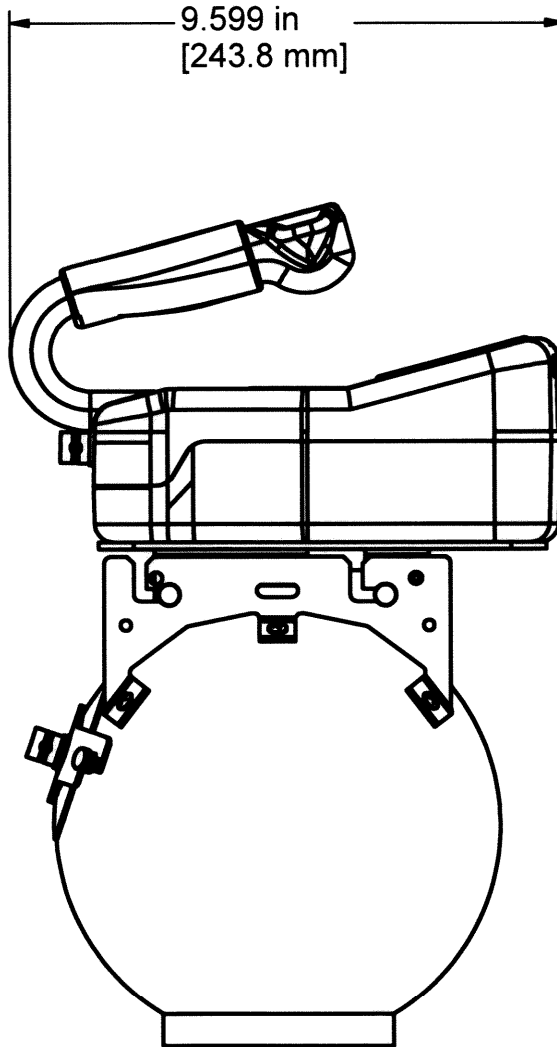
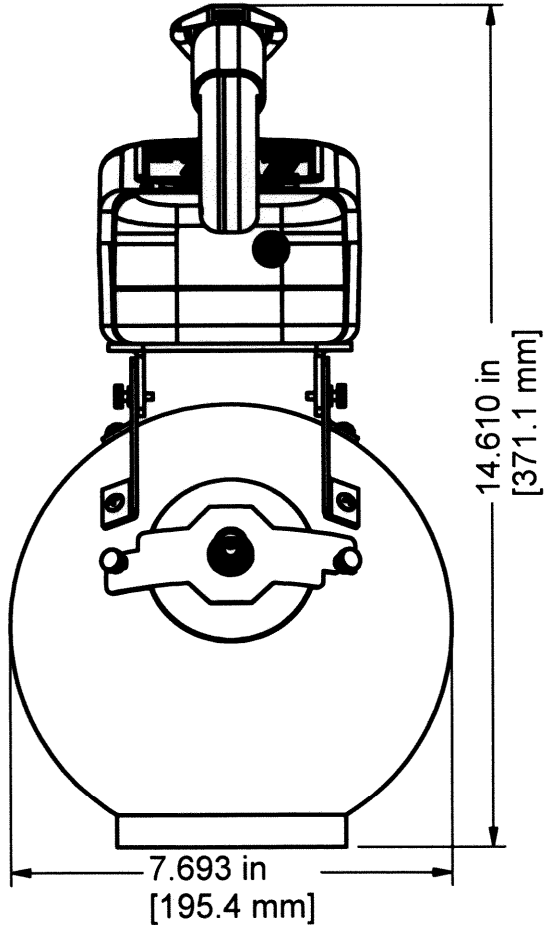
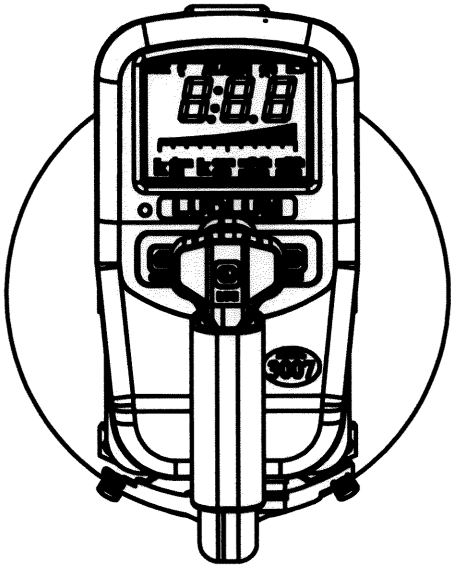

DWN	DATE	CHK	DATE	APP	DATE
JGW	2-27-23			JGW	2-28-23
<b>DWG NUM: 4519-194</b>				<b>SCALE: .3</b>	
<b>TITLE M 3007 OVERALL</b>					
 <b>LUDLUM MEASUREMENTS, INC.</b> 501 OAK STREET SWEETWATER, TEXAS 79556			<b>SERIES</b> 519	<b>SHEET</b> 194A	



# CONTENTS

<b>Contents</b>	<b>3</b>
<b>List of Figures</b>	<b>7</b>
<b>List of Tables</b>	<b>9</b>
<b>1 Introduction</b>	<b>11</b>
<b>2 Getting Started</b>	<b>13</b>
2.1 Unpacking and Repacking . . . . .	13
2.2 Battery Installation . . . . .	13
2.3 Turning the Instrument On . . . . .	14
2.4 Instrument Diagnostics . . . . .	16
2.4.1 Date . . . . .	16
2.4.2 Definitions . . . . .	17
2.4.3 Calibration Due . . . . .	17
2.5 Instrument Operational Test . . . . .	18
2.6 Detector Failure Diagnostic . . . . .	19
2.6.1 Detector Loss of Count . . . . .	19
2.6.2 Detector Over Max . . . . .	19
2.6.3 Detector Over Range . . . . .	20
2.6.4 Detector Overload . . . . .	20
2.7 Instrument Use And Controls . . . . .	20
2.7.1 ON/AUD Button: . . . . .	21
2.7.2 UNITS Button: . . . . .	22
2.7.3 DETECTOR Button: . . . . .	23
2.7.4 MODE Button: . . . . .	23
2.7.5 LOG Button: . . . . .	24
2.8 RATE Mode Operation . . . . .	24
2.9 MAX Mode Operation . . . . .	25
2.10 COUNT Mode Operation . . . . .	26
2.11 DOSE Mode Operation . . . . .	30
<b>3 Specifications</b>	<b>33</b>
<b>4 Setup Mode</b>	<b>37</b>
4.1 Setup Overview . . . . .	37
4.2 Setup Parameters . . . . .	38
4.3 Entering Setup Mode . . . . .	40
4.4 Setup Mode Operation . . . . .	42
4.5 Model 3007i List of Parameters (in order) . . . . .	43
4.6 Page 1 - Device . . . . .	46
4.7 Page 2 - Datalogging . . . . .	49

4.8	Page 3 - Configuration . . . . .	50
4.9	Page 4 - Calibration . . . . .	52
4.10	Page 5 - Channel 1 . . . . .	55
4.11	Page 6 - Unit 1 . . . . .	57
4.12	Page 7 - Unit 2 . . . . .	61
4.13	Page 8 - Reset (WARNING!!!) . . . . .	66
<b>5</b>	<b>Datalogging</b>	<b>67</b>
5.1	Datalogging Operation – Mode 1 . . . . .	67
5.2	Datalogging Operation – Mode 2 . . . . .	68
5.3	Datalogging Operation – Mode 3 . . . . .	69
5.4	Format . . . . .	70
<b>6</b>	<b>Software</b>	<b>71</b>
6.1	Connecting to Lumatic 2.0 Calibration/Configuration Software . . . . .	71
<b>7</b>	<b>Advanced Features</b>	<b>73</b>
7.1	Dead Time Correction . . . . .	73
7.2	Units . . . . .	73
7.3	R to Sv Conversion . . . . .	74
7.4	Software Calibration Tools . . . . .	74
7.5	Hardware Correction . . . . .	74
7.6	Other Device Data . . . . .	75
7.7	Battery Life . . . . .	75
7.8	Real-time Streaming . . . . .	75
<b>8</b>	<b>Safety Considerations</b>	<b>77</b>
8.1	Environmental Conditions for Normal Use . . . . .	77
8.2	Warning Markings and Symbols . . . . .	77
8.3	Cleaning and Maintenance Precautions . . . . .	78
<b>9</b>	<b>Revision History</b>	<b>79</b>
<b>10</b>	<b>Recycling</b>	<b>81</b>
<b>11</b>	<b>Options</b>	<b>83</b>
<b>12</b>	<b>Standard Parts List</b>	<b>85</b>
<b>A</b>	<b>Auxiliary Communications</b>	<b>87</b>
A.1	AuxComm Overview . . . . .	87
A.2	Requirements . . . . .	87
A.3	Usage . . . . .	87
A.3.1	AuxComm Usage - Hot Key . . . . .	87
A.3.2	AuxComm Usage - Pairing . . . . .	88
A.4	Settings . . . . .	90
A.4.1	AuxComm Setting - Mode . . . . .	90
A.4.2	AuxComm Setting - Off Time . . . . .	91

---

A.4.3	AuxComm Setting - Pwr Mode . . . . .	91
A.4.4	AuxComm Setting - Write Protect . . . . .	91
A.4.5	AuxComm Setting - Encryption . . . . .	92
A.4.6	AuxComm Setting - Auto Mode Interval . . . . .	92



# LIST OF FIGURES

2.1	Startup Display (All Segments Shown)	14
2.2	Hardware Revision Levels	14
2.3	Firmware Version Display	15
2.4	Battery Voltage Display	15
2.5	Startup Display Showing 189 Stored Data Records	16
2.6	Instrument Date Reset (Audio Alarm)	16
2.7	Definitions Reset (Audio Alarm)	17
2.8	Calibration Due (Audio Alarm)	18
2.9	Detector Loss of Count Display (Display Will Flash)	19
2.10	Detector Over Max (Display Will Flash)	19
2.11	Detector Over Range (Display Will Flash)	20
2.12	Detector Overload Alarm (Display Will Flash)	20
2.13	WiFi Symbol	22
2.14	RATE Mode Displaying Background Radiation Rate	25
2.15	MAX Mode Display With ALARM Indication	26
2.16	COUNT Mode Displaying COUNT Timer of 5 Minutes, 30 Seconds	29
2.17	COUNT Mode Displaying COUNT Timer of 100k Seconds	30
2.18	DOSE Mode Operation Display	31
4.1	Backlight/Setup Protect Dipswitch	41
4.2	Setup Page Selection Display (showing page 4-CAL)	42
4.3	Detector Operation Modes	50
5.1	Displaying Datalog Table Index of 12	68
5.2	Displaying Datalog Location ID Table Index of 36	69
A.1	Example – Device Selection In Lumic Linker App (iOS)	89
A.2	Example – Pairing	89
A.3	Example – Model 3000 series Found in Lumic Linker App (iOS)	89
A.4	Example – Entering PIN In Lumic Linker App (iOS)	89
A.5	Example – Lumic 2.0 Calibration Software	90





# LIST OF TABLES

2.1	COUNT Mode Units and Result . . . . .	28
7.1	Features That Affect Units in All Modes . . . . .	74
12.1	Standard Parts List . . . . .	85
A.1	AuxComm Mode . . . . .	90
A.2	AuxComm Auto Off Time . . . . .	91
A.3	AuxComm Power on at Boot-up . . . . .	91
A.4	AuxComm Write Protect . . . . .	91
A.5	AuxComm Encryption . . . . .	92
A.6	AuxComm Auto Mode Interval . . . . .	92



## INTRODUCTION

The Model 3007i is an ergonomic instrument which can be used for radiation survey purposes. The Model 3007i features the ability to measure radiation in count rate, exposure/dose rate, activity rate, integrated exposure/dose, time-averaged rates, and scaler counts. It includes an external radiation detector to detect neutron radiation. The Model 3007i version also includes the addition of an internal detector for tracking user exposure rate or dose.

The Model 3007i features a large backlit LCD (liquid crystal display), an audio warning, and easy, intuitive use. The unit body is made of lightweight but durable plastic. It is intended for outdoor use and can resist splashing water. The foam grip provides a comfortable, ergonomic grip but may be removed for ease of decontamination.

There are different versions of the Model 3007i - the Model 3007i and the Model 3007Bi. The difference is the detector's boron moderation. The Model 3007Bi has more boron moderation, which helps with the over-response of the 5 keV region. However, the Model 3007i has better sensitivity than the Model 3007Bi. (Unless specifically named, references to the Model 3007i in this manual will refer to both the Model 3007i and the Model 3007Bi.)

Four modes of operation are available for the Model 3007i – RATE, MAX, COUNT, and DOSE.

RATE mode operation will display the current count, exposure/dose rate, or activity rate.

MAX mode is used to capture the highest count, activity, or exposure/dose rate detected – useful for finding a peak rate when the display is not visible. Two sets of units (primary and secondary) for RATE and MAX modes can be chosen from among cps, cpm, Bq, Bq/cm<sup>2</sup>, dpm, rem/hr, R/h, or Sv/h. The user can switch between these two units by simply pressing the UNITS button.

COUNT mode allows the user to perform a count for a predetermined time. Depending on the count units chosen, the result can be a scaler count (in counts or disintegrations), a time-averaged rate (cpm, dpm, Bq, Bq/cm<sup>2</sup>, cps), a time-averaged exposure or dose (R/h, Sv/h, rem/h), or an integrated exposure or dose rate (R, Sv, rem).

DOSE mode allows the user to view a real time integrated dose (R, Sv, or rem) with the possibility of continually monitoring the integrated dose during other modes of operation.

The Model 3007i primary keypad includes four push buttons: ON/AUD to toggle instrument

power and adjust the click audio level, UNITS to change between available units, DETECTOR to change between available detectors, and MODE to switch between available modes.

The standard handle includes a LOG button that allows the instrument to log up to 1000 data points when activated with the optional Lumic Datalogging Kit.

The display will be automatically back-lit if light levels are low or can be set to a user defined light level. The display back-light can also be configured for “Continuous On” operation. RATE, MAX, COUNT, and DOSE modes can be silent or utilize a “click” audio; the “click” audio is always silent during COUNT mode by default.

Setup of the instrument is accomplished through the front-panel buttons, or through Lumic 2.0 software available from Ludlum Measurements.

Front-panel setup can be disabled via the internal switch on the Model 3007i in order to protect settings from inadvertent changes. When the settings are protected, the user can view the settings or modify a limited number of settings as defined with the Lumic software. Using the Lumic software, the Model 3007i can be configured to allow changes to the alarms and or count time even when in protect mode.

The unit is operated with four alkaline AA batteries for operation from -20 to 50 °C (-5 to 122 °F). Battery life for the Model 3007i is approximately 175 hours under normal usage. A low-battery indicator on the LCD warns when less than 16 hours of battery life remain.

The Model 3007i may optionally be provided with a 1/8-inch stereo headphone jack that would allow for headphone use for audio output. It is located to the left of the detector connector.

If a headphone jack is not in use, the Model 3007i may optionally be provided with an RS232 serial output for connection to PC or other electronic device.

For more advanced use: See Appendix A for information on our Auxiliary Communications features, which allow the instrument to expand its capabilities with a variety of external devices through a standard serial interface.

## GETTING STARTED

### 2.1 Unpacking and Repacking

Remove the calibration certificate and place it in a secure location. Remove the instrument and ensure that all of the items listed on the packing list are in the carton. Check individual item serial numbers and ensure calibration certificates match between instruments and detectors (if applicable). The Model 3007i serial number is located on a label on the front side of the unit.

To return an instrument for repair or calibration, provide sufficient packing material to prevent damage during shipment.

Every returned instrument must be accompanied by an Instrument Return Form, which can be downloaded from the Ludlum website at [www.ludlums.com](http://www.ludlums.com). Find the form by clicking the “Support” tab and selecting “Repair and Calibration” from the drop-down menu. Then choose the appropriate Repair and Calibration division where you will find a link to the form.

### 2.2 Battery Installation

A low-battery indicator appears at the top of the LCD when less than 16 hours of battery life remain. When this indicator is present, follow these steps to replace the four standard AA batteries:

1. Turn the instrument over so that the bottom of the instrument is facing up.
2. Use a straight, medium-sized screwdriver to turn the single screw on the battery cover one-quarter turn counter-clockwise.
3. Release and remove the battery cover.
4. Replace all four AA batteries.
5. Replace the cover and turn screw one quarter of a turn clockwise to secure.

## 2.3 Turning the Instrument On

Turn the instrument ON by pressing the ON/AUD button for about a second, and then releasing. The instrument should activate all the LCD segments and the audio. Observe the device during this time. If any LCD segments are missing, or audio fails to work, the device is in need of repair. Please refer to Figure 2.1.

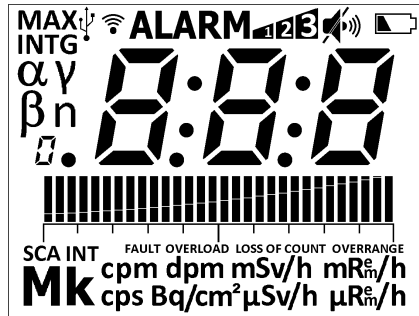

Figure 2.1: Startup Display (All Segments Shown)

The instrument then displays the current revision level of each board installed in the system: main board, internal detector high-voltage board, and auxiliary communications board.

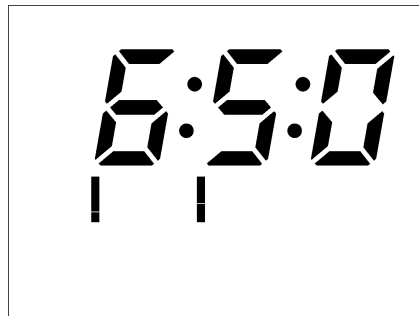

Figure 2.2: Hardware Revision Levels

The tick marks below the hardware revision level define the board generation, which will help with future firmware updates. Use the following table to determine which main processor board is installed in the instrument:

- 1 tick - 5519-001
- 2 ticks - 5519-305
- 3 ticks - 5519-812

Use the following table to determine which high-voltage board is installed in the instrument (if any):

- 1 tick - 5519-187
- 2 ticks - 5519-817

A revision level of 0 indicates that the board is not installed or detected.

Next, the instrument displays the firmware version.

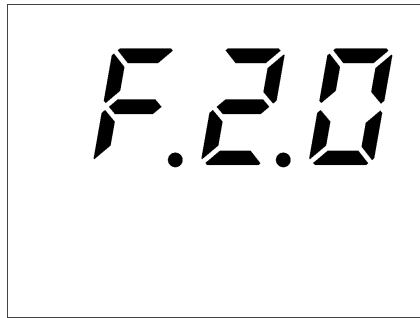

Figure 2.3: Firmware Version Display

The first character defines the firmware type, the second character defines the major version level, and the third character defines the revision level. The build version is not displayed.

The instrument then displays the battery voltage. The low-battery indicator is only displayed to indicate that the value displayed is related to the battery voltage and not that the battery voltage is low.

Should the instrument detect a battery voltage that is high enough to power on, but too low to safely operate, the display will go blank and the low-battery icon will flash. Normal operation will not be available until the batteries have been replaced. Under extreme low-battery conditions, be aware that the unit may not even turn on or may turn itself off abruptly.

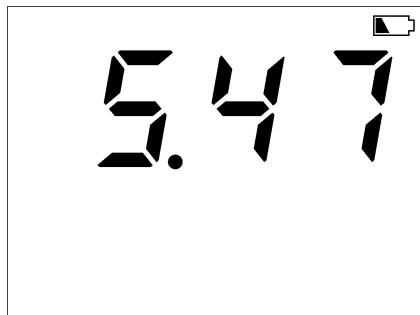

Figure 2.4: Battery Voltage Display

The instrument then displays the number of stored records if datalogging is enabled.



Figure 2.5: Startup Display Showing 189 Stored Data Records

If the Sigma Audio option is selected, the unit will display a countdown from :08 to :01 (in seconds) as the unit measures background radiation levels.

The instrument will then move to normal operation, displaying the current rate for the Primary units (factory default: mR/h). This boot-up process takes about 12 seconds plus another 8 seconds if Sigma Audio is enabled.

## 2.4 Instrument Diagnostics

After the boot process is complete, the instrument will perform some simple diagnostic checks.

### 2.4.1 Date

If the instrument displays the instrument date reset message, this indicates that the real time clock, which maintains the date and time in the instrument, has been reset. This is a common occurrence after installing new batteries into the instrument after an extended period without batteries (typically greater than 15 minutes).



Figure 2.6: Instrument Date Reset (Audio Alarm)

To acknowledge this condition, the a short press of the ON/AUD button will silence the alarm, clear the screen, and resume normal instrument operation. A 'FAULT' message will remain on the screen as a reminder until the instrument power is cycled.



Time and date are necessary when the instrument is configured for datalogging as each log record is time/date stamped. Additionally, time and date are crucial when the instrument is configured to report that a new calibration is due.

### 2.4.2 Definitions

If the instrument displays the definitions reset message, this indicates that the memory which maintains the detector definitions has been reset. This occurs after flashing the instrument with new firmware and is an unwelcome but necessary side effect of this process. As a result, please visit our website and follow our strict posted guidelines prior to installing any new firmware.



Figure 2.7: Definitions Reset (Audio Alarm)

To acknowledge this condition, a short press of the ON/AUD button will silence the alarm, clear the screen, and resume limited instrument operation. A 'FAULT' message will remain on the screen as a reminder until the instrument power is cycled. If after acknowledging this condition the message remains on the screen, then the instrument has suffered a catastrophic failure and should be returned to the factory for service.

After receiving and acknowledging a 'def' alarm message, the instrument should either be refreshed with a copy of the previously stored detector information, or the instrument detectors should be reconfigured and re-calibrated.

### 2.4.3 Calibration Due

If the instrument displays the calibration due message, this indicates that the predefined calibration due date has been exceeded by at least one day. This can be set as a reminder that a new calibration is required; however, it will not affect operation of the instrument past the expiration date. By default, the instrument leaves the factory with the calibration due date set one year from the date of factory calibration. To enable this feature, set the real time clock (RTC) according to the procedures defined in the Setup Menu.

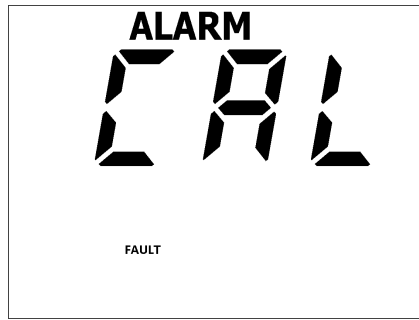

Figure 2.8: Calibration Due (Audio Alarm)

To acknowledge this condition, the a short press of the ON/AUD button will silence the alarm, clear the screen, and resume limited instrument operation. A 'FAULT' message will remain on the screen as a reminder until the instrument power is cycled.

After receiving and acknowledging a 'CAL' alarm message, the instrument should be returned to the appropriate facility for re-calibrated.

## 2.5 Instrument Operational Test

Ensure that the low-battery indicator is not present. If the low-battery indicator is present, replace the batteries as soon as possible. Should the instrument detect a battery voltage that is high enough to power on, but too low to safely operate, the display will blank and the low-battery icon will flash. Normal operation will not be available until the batteries have been replaced. Under extreme low-battery conditions, be aware that the unit may not even turn on or may turn itself off abruptly.

To assure proper operation of the instrument and detectors(s) between calibrations, an instrument operational check including battery test and instrument test should be performed at least daily or prior to use, whichever is less frequent. A reference reading (or readings) with a dedicated check source should be obtained with the detector(s) in a constant and reproducible manner at the time of calibration or at the time the instrument is received in the field.

If at any time the instrument fails to read within 20% of the reference reading when using the dedicated check source, it should be removed from service and sent to a calibration facility for recalibration and/or repair. If desired, multiple readings may be taken at different distances and/or with different sources so that other scales are checked.

Example of a Check Source reading:

Check Source # \_\_\_\_\_ Rate \_\_\_\_\_ Units \_\_\_\_\_

Once this procedure has been completed, the instrument is ready for use.

## 2.6 Detector Failure Diagnostic

Note that the Model 3007i has its own diagnostic tests to ensure that the detector is functioning correctly. The Model 3007i can detect when the radiation detector is malfunctioning and will flash the display to indicate a fault.

### 2.6.1 Detector Loss of Count

If the detector stops detecting radiation for a settable number of seconds, the Model 3007i will flash to indicate which units have been affected by the loss of count event. This indication is common if the unit is powered up without a detector connected. If this indication is observed with a connected detector, remove the unit from service and have it evaluated by a qualified repair and calibration technician.

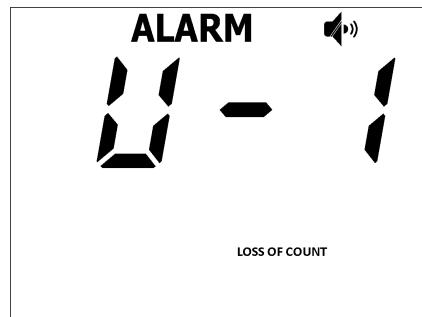

Figure 2.9: Detector Loss of Count Display (Display Will Flash)

### 2.6.2 Detector Over Max

If the detector exceeds the programmed maximum value for the given unit, the instrument flashes the maximum value for the currently selected units and the MAX icon as a warning. Additionally, the ALARM icon is displayed at the top of the screen and an audio alarm sounds. The user should be aware that the alarm, including the audio, can only be cleared by removing the instrument from the radiation field. The maximum configurable value which may be set for any unit in any mode of operation is 999 M.

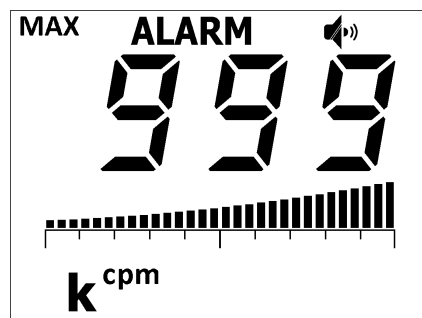

Figure 2.10: Detector Over Max (Display Will Flash)

### 2.6.3 Detector Over Range

If the detector is exposed to high levels of radiation or has an internal malfunction that causes it to count high or excessively, the unit flashes all 8's for the currently selected units as a warning. Additionally, the ALARM icon is displayed at the top of the screen, an audio alarm sounds (which can be silenced by the an long press of the ON/AUD button ), and the OVER-RANGE icon is displayed. The user should ensure whether this condition is being caused by a high radiation field, by a shorted cable, or by internal malfunction.

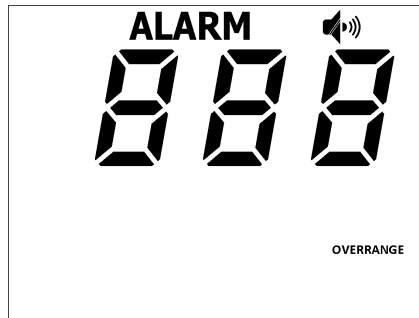

Figure 2.11: Detector Over Range (Display Will Flash)

### 2.6.4 Detector Overload

As another diagnostic test, the Model 3007i monitors the HV supply's detector current. A current overload threshold can be set via Setup Mode. (A setting of 0 disables this alarm.) In general, this alarm setting can be used to detect when there is some detector failure, a cable failure, or a possible high level of radiation. When this alarm is triggered, the LCD will display the OVERLOAD and ALARM icons, three dashes will be displayed in place of the numerical values, and an alarm tone will sound. Once the detector current goes below the threshold, the Model 3007i will return to normal operation.

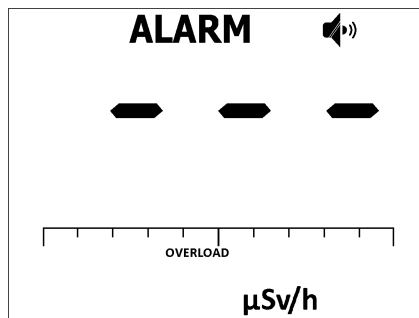

Figure 2.12: Detector Overload Alarm (Display Will Flash)

## 2.7 Instrument Use And Controls

With four front-panel buttons and one handle button (as seen in front-panel drawing in front of manual), the Ludlum Model 3007i offers many features in a small package. Each button

may be pressed and held for a predetermined length of time, signified by instrument beeps, to access unique instrument features.

As the button is pressed, the instrument will beep to indicate the user has reached a new level of button access.

- A short press and release, or one beep, indicates the instrument button is at the first level of operation.
- A long press and release, or two beeps, indicates the instrument button is at the second level of operation.
- An extra-long press and release, or three beeps, indicates the instrument button is at the highest level of operation.

By default, the majority of functions are assigned to short presses of the buttons.

### **2.7.1 ON/AUD Button:**

Used to power the Model 3007i ON and OFF and adjust the audio level (mute, low, medium, or high).

- Power On: Press for approximately one second and release (all LCD segments will activate and firmware version will be shown).
- Power Off: Press and hold for approximately five seconds. The display will show a 3, 2, 1 countdown after the third beep. Releasing the button during shutdown will return the device to the previous state of operation. At completion of the shutdown count, the LCD will go blank (unless a USB cable is connected in which case the USB icon will flash).

#### **Short Press (press and release after one beep):**

- Normal Operation: Will increment the audio through four volume levels including mute, low, medium, and high.
- Alarm: Will acknowledge an alarm condition by silencing the audio.

#### **Long Press (press and release after two beeps):**

- In RATE mode, it will reset the currently displayed rate if the user has permission (permission set from Lumic 2.0 software).
- In MAX mode, it will reset the current MAX value if the user has permission to also reset the RATE mode.

- In COUNT mode, it will:
  - If COUNT mode is ready: It will initialize the count.
  - If COUNT mode is in progress: It will reinitialize the instrument to begin the next count displaying the count timer.
  - If COUNT mode is complete: It will reset the count mode and reinitialize the instrument to begin the next count.
- In DOSE mode, it will reset the displayed integrated dose if the user has permission (permission set from Lumic 2.0 software).

#### **Extra-Long Press (press and release after three beeps):**

- After 3 beeps, the countdown should begin to power off the instrument. Releasing the button after the third beep will restart the setup menu four-second counter, allowing you quick access into the setup menu by performing an extra-long press of the MODE, without having to cycle power to the instrument.

### **2.7.2 UNITS Button:**

In default operation, the display shows the current count rate using the Primary units. A short press of the UNITS button (1 beep) will switch between Primary and Secondary units (or Tertiary units in the case of alpha/beta configuration).

#### **Short Press (press and release after one beep):**

- Used to switch between Primary and Secondary units (or Tertiary units in the case of alpha/beta configuration) in all available modes.

#### **Long Press (press and release after two beeps):**

- Currently has no effect.

#### **Extra-Long Press (press and release after three beeps):**

- Enables/disables the Auxiliary Communications as indicated by a wifi symbol on the top of the LCD screen.



Figure 2.13: WiFi Symbol

### 2.7.3 DETECTOR Button:

The Detector button's primary function is to switch between available enabled detectors.

#### Short Press (press and release after one beep):

- Used to select the actively displayed detector, as evidenced by the corresponding EXT or INT LED.

#### Long Press (press and release after two beeps):

- Currently has no effect.

#### Extra-Long Press (press and release after three beeps):

- When in setup mode viewing the Detector Overload threshold, it is used to toggle between the live current value and the set point value.

### 2.7.4 MODE Button:

A short press of the MODE button (1 beep) will switch the instrument to the next available mode. After the RATE mode, the default is MAX mode, which will display the highest count rate detected. Another short press of the MODE button will switch the instrument to COUNT (scaler) mode, which will display the COUNT timer. One more short press of the MODE button will display the DOSE (INTG) mode. Note that any combination of the MAX, COUNT, and DOSE modes can be locked out in the setup process.

#### Short Press (press and release after one beep):

- Used to advance between the four operating modes: RATE, MAX, COUNT, and DOSE. Note that any combination of RATE, MAX, COUNT, and DOSE modes may be disabled from use.
- When in setup mode viewing the Detector Overload threshold, it is used to toggle between the live current value and the set point value.

#### Long Press (press and release after two beeps):

- Currently has no effect.

#### Extra-Long Press (press and release after three beeps):

- During instrument initialization and within 4 seconds after the power-up screen, an extra-long press of the MODE button will place the instrument into setup mode.
- Once the instrument is displaying normal operation, and 4 seconds have passed, the button no longer has any effect.

### 2.7.5 LOG Button:

#### Short Press (press and release after one beep):

- In RATE mode, it will log the current rate reading if datalogging is enabled.
- In MAX mode, it will log the current MAX value if datalogging is enabled.
- In COUNT mode, it will:
  - If COUNT mode is ready: Initiate a count. Upon completion, the result will be logged if datalogging is enabled.
  - If COUNT mode is in progress: Button has no effect.
  - If COUNT mode is complete: Button will log the current result.
- In DOSE mode, it will log the current DOSE value if datalogging is enabled.
- If datalogging in Mode 2 and a log event has been initiated, the button is used to accept the current location ID.

#### Long Press (press and release after two beeps):

- Currently has no effect.

#### Extra-Long Press (press and release after three beeps):

- In COUNT mode, it will:
  - If COUNT mode is ready: It will change the count time to next available count time.
  - If COUNT mode is in progress: It will switch between displaying the count and displaying the count timer.
  - If COUNT mode is complete: It will reset the count mode and reinitialize the instrument to begin the next count.

## 2.8 RATE Mode Operation

In RATE mode, the current count rate will be displayed. The maximum displayable value, regardless of units, is 999 M.

If an alarm is not in progress, a long press of the ON/AUD button will reset the averaged rate before releasing the button. The Reset feature must be enabled through Lumic 2.0 Calibration software and will be disabled when Sigma Audio is enabled.

A short press of the UNITS button will switch the displayed value between the Primary and Secondary Units. If the detector is configured for alpha/beta, the UNITS button will switch



between alpha and beta. A combination of alpha and beta (ex. alpha + beta) can be viewed if Unit 3 is enabled for the detector.

A short press of the ON/AUD button will cycle through the “click” audio volume levels. When Sigma Audio is enabled, a short press of the ON/AUD button will toggle the Sigma Audio volume levels. If multi-level audio is disabled, a short press of the ON/AUD button will toggle audio between Off and On.

If an alarm condition is present, a short press of the ON/AUD button will acknowledge and turn off the continuous tone alarm audio. Under an alarm condition, the ALARM display indicator will remain on as well as the alarm level icon. Alarms are non-latching in RATE mode. When Sigma Audio is enabled, and an alarm condition is not present, an long press of the ON/AUD button will reset the Sigma Audio alarm level. The Sigma count can only be reset in RATE mode.

If sigma audio and device rate reset are both enabled, the device rate reset will automatically be disabled.

A short press of the LOG button, if datalogging is enabled, will log the currently displayed rate.

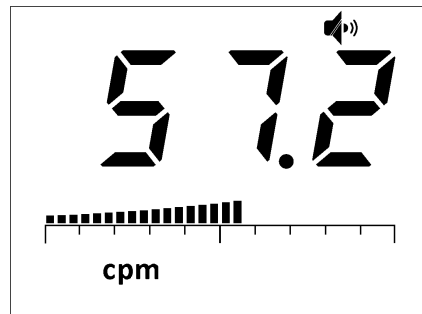

Figure 2.14: RATE Mode Displaying Background Radiation Rate

## 2.9 MAX Mode Operation

While in MAX mode, the highest detected count rate (since MAX mode was selected) is displayed. The word MAX will be displayed when in MAX mode.

A short press of the UNITS button will switch the displayed value between the Primary and Secondary Units. If the detector is configured for alpha/beta, the UNITS button will switch between alpha and beta. A combination of alpha and beta (ex. alpha + beta) can be viewed if Unit 3 is enabled for the detector.

A short press of the ON/AUD button will cycle through the “click” audio volume levels. When Sigma Audio is enabled, a short press of the ON/AUD will toggle the Sigma Audio volume levels. If multi-level audio is disabled, a short press of the ON/AUD button will toggle audio between Off and On.

Under a non-alarm or alarm condition, an long press of the ON/AUD button will reset the

display. When Sigma Audio is enabled, the Sigma Audio alarm level cannot be reset in Max Mode.

If an alarm condition is present, a short press of the ON/AUD button will acknowledge and turn off the continuous tone alarm audio. (The “click” audio will remain as selected under non-alarm conditions.) Alarms are latching in MAX Mode. Under an alarm condition, the ALARM display indicator will remain on until the display is reset.

If other operational modes are available, a short press of the MODE button will move to the next available operational mode.

A short press of the LOG button, if datalogging is enabled, will log the currently displayed MAX value.

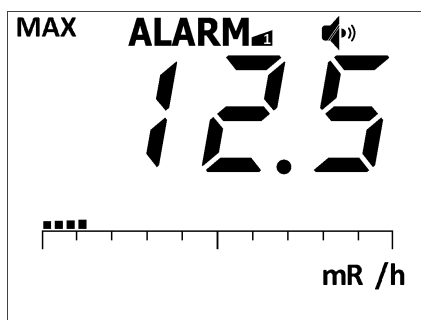

Figure 2.15: MAX Mode Display With ALARM Indication

## 2.10 COUNT Mode Operation

When entering COUNT Mode from another operational mode, the currently selected COUNT Unit will be displayed for approximately one second. The purpose of COUNT mode is to count for a predetermined amount of time, and to display the results on the display. Predefined count times of 6 seconds, 30 seconds, 1 minute, 2 minutes, 5 minutes, and 10 minutes are available as well as a user-defined count time and continuous counting operation (count time displayed as 0). The maximum user-defined count time is 999e6 (999000000) seconds or approximately 31.68 years. The maximum displayable value, regardless of units, is 999 M.



Predetermined count times will be displayed in clock mode. User-defined count times will be displayed in clock mode if less than 10 hours; otherwise, they will be displayed in second counts until 10 hours remain. See figures: 2.16 and 2.17.

Count mode operation is very flexible, depending on the units chosen. A common choice is for the count mode to just perform a scaler count for a specified time, with a resulting answer in counts (equaling detected radiation events).

There are three different options for COUNT mode, which can be set through software.

Go to “Cnt Display Mode” in the Dev tab. Select the desired option:

- Timer: Will only show the countdown timer while the timer is active (default selection).
- Readings: Will only show the current gathered reading.
- Timer Readings: Will cycle between showing the countdown timer and the current reading.



A short press of the LOG button will start a count and automatically log the result. An extra-long press of the LOG button during the count will toggle the display between the timer and reading. Audio 'clicks' are disabled in COUNT mode by default but may be enabled in software (see Lumic 2.0 software parameter Dev-Cnt-Audio Mode).

Dev-Cnt-Audio Mode will enable or disable the click audio during a COUNT.

- Off - always off
- On - always on
- W\_Count - audio is only enabled during an active count



Sigma audio is disabled in Count Mode. If a result in terms of activity is desired, the scaler count can also be in units of "d" or disintegrations. But if the count units are chosen to be cpm or cps, then the resulting answer is an averaged count rate over the time interval. Similarly, if count units of Bq or dpm are chosen, the resulting answer is an averaged disintegration rate.



If the user desires the instrument to show results in terms of disintegrations/area (eg. dpm/100 cm<sup>2</sup>), then the instrument should be configured for dpm and the appropriate factor should be placed in the Efficiency parameter. Bq/cm<sup>2</sup> will use the stored detector active area and perform the calculations internally so no manipulation of the efficiency is needed.

Other choices are to have count mode units of R/h or Sv/h, in which case the COUNT mode result is an averaged exposure or dose rate. But if count mode units of R or Sv are chosen, the result is shown in accumulated exposure or accumulated dose over the chosen count time. The following tables lists the possibilities:

Table 2.1: COUNT Mode Units and Result

UNITS	RESULT
c	counts per count time
d	disintegrations per count time
cpm, cps	count rate averaged over the count time
dpm, Bq	disintegration rate, averaged over the count time
R/h, Rem/h, Sv/h	exposure or dose rate, averaged over the count time
R, Rem, Sv	integrated exposure or dose over the count time

In COUNT mode, operation depends on the current state of the Count Timer.

#### When the Count Timer is Ready:

- The display will show the Count Time.
- A short press of the UNITS button will switch between the Primary and Secondary Count Units. If the detector is configured for alpha/beta, the UNITS button will switch between alpha and beta count units. A combination of alpha and beta (ex. alpha + beta) can be viewed if Unit 3 is enabled for the detector. The newly selected Count Units will be displayed for approximately one second, and the display will then return to the Count Timer.
- A short press of the LOG button will initiate a count (logs the displayed result upon completion if datalogging is enabled) or an long press of the ON/AUD button (will not log results) initiates the Count Timer.
- If other operational modes are available, a short press of the MODE button will move to the next available operational mode.
- An extra-long press of the LOG button will change the count time to the next available time.

#### When the Count Timer is Active:

- The display will show either Count Time (default), both Count Time and Counts, or just counts, depending on Device Count Display Mode.
- an long press of the ON/AUD button will reset the Count Timer (and not log results if previously requested).
- Click audio, if enabled, can be adjusted by a short press of the ON/AUD button.
- An extra-long press of the LOG button will switch between the Count Timer and the counts.
- If an alarm condition occurs, the ALARM display indicator will turn on, and the Alarm audio will sound as soon as the count is over the alarm threshold. (If the count unit is

an averaged rate, it is possible for the ALARM icon to come on during the count, but if the averaged rate falls below the alarm threshold by the end of the count, no ALARM will be active.) If the instrument is only displaying the Count Time, the instrument will alternate between the Count Time and the counts units which have generated the alarm.

- If other operational modes are available, a short press of the MODE button will cancel the current Count Timer and move to the next available operational mode.

#### When the Count Timer has Finished:

- The display will show either the accumulated total for c, d, R, Rem and Sv, or the timed ratemeter average for cps, cpm, Bq, dpm, or the average exposure or average dose in R/h, Rem/h, and Sv/h.
- If datalogging is enabled and logging the count results was previously requested, the results will be logged to the log buffer.
- A short press of the UNITS button will switch between the Primary and Secondary Count Units. If the detector is configured for alpha/beta, the UNITS button will switch between alpha and beta. A combination of alpha and beta (ex. alpha + beta) can be viewed if Unit 3 is enabled for the detector.
- an long press of the ON/AUD button will reset the Count Timer and initialize for a new count.
- If an alarm condition occurred during the Timed Count, a continuous audio tone will sound, and the ALARM display indicator will already be on. To acknowledge and turn off the continuous tone alarm audio, a short press of the ON/AUD button is required. To clear the alarm condition and reset the Count Timer, an long press of the ON/AUD button is required.
- If other operational modes are available, a short press of the MODE button will move to the next available operational mode.



Figure 2.16: COUNT Mode Displaying COUNT Timer of 5 Minutes, 30 Seconds



Figure 2.17: COUNT Mode Displaying COUNT Timer of 100k Seconds



When using COUNT mode on the Model 3007i internal detector, it is possible for an internal detector integrated dose alarm to occur. If an internal detector integrated dose alarm occurs during this time, the internal detector COUNT mode timer will pause while the integrated dose alarm is displayed on the instrument screen and COUNT mode will resume once the instrument returns to the COUNT mode screen. No counts in COUNT mode should be lost.

## 2.11 DOSE Mode Operation

While in DOSE mode, the current accumulated dose will be shown. The icon INTG will be displayed when in DOSE mode.

A short press of the UNITS button will switch the displayed value between the Primary and Secondary Units. If the detector is configured for alpha/beta, the UNITS button will switch between alpha and beta. A combination of alpha and beta (ex. alpha + beta) can be viewed if Unit 3 is enabled for the detector.

A short press of the ON/AUD button will cycle through the “click” audio volume levels. If multi-level audio is disabled, a short press of the ON/AUD button will toggle audio between Off and On. Sigma Audio is disabled in DOSE mode.

Under a non-alarm or alarm condition, an long press of the ON/AUD button will reset the display. This feature must be enabled in software.

If an alarm condition is present, a short press of the ON/AUD button will acknowledge and turn off the continuous tone alarm audio. (The “click” audio will remain as selected under non-alarm conditions.) Alarms are latching in DOSE Mode. Under an alarm condition, the ALARM display indicator will remain on until the display is reset.

If other operational modes are available, a short press of the MODE button will move to the next available operational mode.

A short press of the LOG button, if datalogging is enabled, will log the currently displayed DOSE value.

The maximum displayable value, regardless of units, is 999 M.

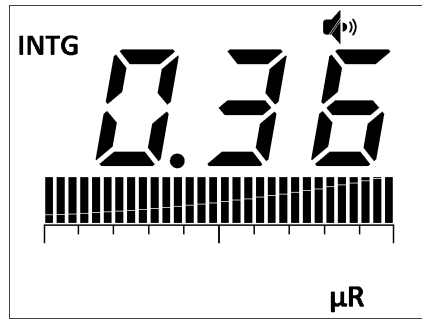

Figure 2.18: DOSE Mode Operation Display





## SPECIFICATIONS

**Detector:** <sup>2</sup> atm <sup>3</sup>He proportional detector, 1.6 cm diameter x 2.5 cm thick (0.6 x 1.0 in.), surrounded by 19.6 cm (7.7 in.) diameter high density polyethylene sphere

**Sensitivity:**

**Model 3007i:** typically 10 cpm per  $\mu\text{Sv/h}$  (100 cpm per mrem/hr) (<sup>241</sup> AmBe fast neutrons)

**Model 3007Bi:** typically 4.5 cpm per  $\mu\text{Sv/h}$  (45 cpm per mrem/hr) (<sup>241</sup> AmBe fast neutrons)

**Energy Response:** provides an appropriate inverse RPG curve for neutrons from thermal to 12 MeV

**Ext. Gamma Rejection:** < 10 cpm through 0.1 Sv/h (10 R/hr) (<sup>137</sup>Cs gamma)

**Ext. Threshold:** -2mV

**Ext. High Voltage:** adjustable from 300 to 2400 Vdc

**Ext. Operating Voltage:** approximately 1200 Vdc

**Internal (Int.) Detector:** Energy Compensated GM (Range: 0 to 50 mSv/h [0 to 5 R/hr]) or scintillation detector

**Linearity:** readings within 10% of true value

**Modes:** Four operational modes including rate, max, integrated dose, and count

**LCD Display:** three-digit LCD with bar graph, 13 units, five multipliers, two mode icons, three alarm levels, and four fault messages, as well as USB, wireless, audio, and low-battery icons

**Alarms:** three adjustable alarm setpoints for each unit in all four modes of operation

**Overload Protection:** high count rate saturation protection designed to prevent the false display of lower count rates; if the instrument detects an overload condition, it will display a graphic OVERLOAD icon and trigger an audio warning

**Zero Protection:** after typically 60 seconds of no pulses from the detector, the alarm audio will be triggered, a graphic LOSS OF COUNTS icon will be displayed, and the affected unit will be displayed

**Overrange:** if the reading should exceed the predefined detector range, the instrument will flash a maximum reading, display a graphic OVERRANGE, and trigger an audio warning

**Headphone Jack (optional):** 1/8 inch stereo jack for use with headphones for audio output. It will be located to the left of the instrument handle.

**Backlight:** built-in ambient light sensor automatically activates low-power LED backlight or backlight level may be user defined, unless internal dip switch is set to continuous-on (will reduce battery life)

**User Controls:**

- ON/ AUD – extra-long press to turn ON, short press to adjust audio level, extra-long press plus 3 seconds to turn OFF
- UNITS – changes the units between count rate, dose/exposure, or activity
- DETECTOR – short press to change between external and internal detectors
- MODE – short press alternates between available modes: RATE (count rate), MAX (captures peak rate), COUNT (user-selectable preset count time from 0 to approximately 31.68 years), and DOSE.
- LOG - short press to log current display (or initiate count in COUNT mode), extra-long press to change count in COUNT mode. Data logging requires Lumic Data Logger Kit. (See chapter 11 Options.)

**Response Time:** auto-response slow or fast, fixed slow or fast, or user-selectable from 1 to 60 seconds

**Audio:** approximately 4.5 kHz; click audio greater than 65 dB at 0.6 m (2 ft), alarm audio at greater than 72 dB

**Power:** four alkaline “AA” batteries

**Battery Life:** approximately 175 hours of operation, 16-hour low-battery warning

**Maximum Current:** 50 mAdc

**Construction:** high-impact plastic with water-resistant rubber seals and separate battery compartment

**Temperature Range:** -20 to 50 °C (-5 to 122 °F), may be certified for operation from -40 to 65 °C (-40 to 150 °F)

**Environmental Rating:** NEMA (National Electrical Manufacturers Association) rating of 3x or IP (Ingress Protection) rating of 53

**Size:** 37.1 x 19.5 x 24.4 cm (14.6 x 7.7 x 9.6 in.) (H x W x L)

**Weight:** 5.5 kg (12.2 lb) with batteries

**NOTE:** Tested in a 100mR/hr field. Testing in a 100 $\mu$ R/hr field yielded higher than expected response for energies greater than 1 MeV, but still within 40% of true value.



## SETUP MODE



Only advanced users or administrators should consider changing any of the parameters in the following section. Incorrect settings could jeopardize the safety of users depending on this instrument.

### 4.1 Setup Overview

Your instrument has been shipped from Ludlum Measurements only after passing electronic checkout, a 24-hour burn-in process, and a careful calibration process. Calibration papers are supplied with each instrument shipped from Ludlum Measurements.

Recalibration should be accomplished after a predetermined calibration frequency (Ludlum Measurements, Inc. recommends no more than a one-year interval), or when the operation of the instrument is suspect or maintenance has been performed on the instrument. Recalibration is not normally required following instrument cleaning or battery replacement. While recalibration does not require any special tools or software to perform, Lusic software available through Ludlum Measurements, Inc. will greatly ease calibration, especially when second-order deadtime correction (extended calibration) is being utilized. As a result, the use of Lusic software is highly recommended.

Ludlum Measurements offers a full-service repair and calibration department. Not only do we repair and calibrate our own instruments, we also service most other manufacturers' instruments. Calibration procedures are available upon request for customers who choose to calibrate their own instruments.



Ludlum Measurements, Inc. recommends recalibration at intervals no greater than one year, assuming that regular operational checks are performed. Check the appropriate local, state, and federal regulations to determine required recalibration intervals.

## 4.2 Setup Parameters

Setting	#	Setup Parameter	Model 42-49	Model 42-49B	Internal Detector
dev	1	Multi-level Audio	on		
dev	2	Backlight Threshold	Aut		
dev	3	Auto Shutdown Time	0		
dev	4	AuxCOM COM Mode	SLU		
dev	5	AuxCOM PWR Mode	hot		
dev	6	AuxCOM Auto Interval	0		
dev	7	Real Time Clock Month	01		
dev	8	Real Time Clock Day	01		
dev	9	Real Time Clock Year	019		
dev	10	Real Time Clock Hour	12		
dev	11	Real Time Clock Minute	00		
dev	12	Real Time Clock Second	00		
LOG	1	Enabled	on		
LOG	2	Mode	1		
LOG	3	Location Mode 3	1		
LOG	4	Mode 3 Timer	60		
CFG	1	Detector Enable	En		
CFG	2	Operational Modes	r-c [MAX]		r - c [INTG]
CFG	3	Bar Graph Mode	Std		
CFG	4	Response Rate	F-F		
CFG	5	Response Time	60		
CFG	6	Background Audio	oFF		
CFG	7	Background Alarms	oFF		
CFG	8	Audio Mode	clc		
CAL	1	High Voltage Setpoint	1200		550
CAL	2	Calibration Constant Mantissa	600	270	600
CAL	3	Calibration Constant Exponent	E04		E05
CAL	4	Dead Time Correction 1	5e-6		80 e-6
CAL	5	Dead Time Correction 2 Mantissa	0		
CAL	6	Dead Time Correction 2 Exponent	e-12		
CAL	7	Detector Current Overload Threshold	-		
CAL	8	Detector Adjustable Scaler Count	0 (continuous)		
CAL	9	Detector Active Area	100		

Setting	#	Setup Parameter	Model 42-49	Model 42-49B	Internal Detector
C-1	1	Channel 1 – Threshold (V)	0.002		0.025
C-1	2	Channel 1 - Window (V)	0 (max value)		
C-1	3	Channel 1 - Efficiency	100		
C-1	4	Channel 1 - Loss of Count Alarm Time	999	60	
C-1	5	Channel 1 - Radiation Icon	n (Neutron)	γ (Gamma)	
U-1	3	Unit 1 - RATE / MAX Alarm 1	2.00 mRem/h	2.00 mR/h	
U-1	4	Unit 1 - RATE / MAX Alarm 2	5.00 mRem/h	5.00 mR/h	
U-1	5	Unit 1 - RATE / MAX Alarm 3	8.00 mRem/h	8.00 mR/h	
U-1	6	Unit 1 - COUNT Units and Minimum Display	0.00 mRem	0.00 μR	
U-1	7	Unit 1 - COUNT Alarm 1	2.00 mRem	2.00 mR	
U-1	8	Unit 1 - COUNT Alarm 2	5.00 mRem	5.00 mR	
U-1	9	Unit 1 - COUNT Alarm 3	8.00 mRem	8.00 mR	
U-1	10	Unit 1 - DOSE Units and Minimum Display	0.000 μRem	0.000 μR	
U-1	11	Unit 1 - DOSE Alarm 1	2.00 mRem	2.00 mR	
U-1	12	Unit 1 - DOSE Alarm 2	5.00 mRem	5.00 mR	
U-1	13	Unit 1 - DOSE Alarm 3	8.00 mRem	8.00 mR	
U-1	14	Unit 1 - Channel	1	1i	
U-2	1	Unit 2 - RATE / MAX Units and Minimum Display	0.00 cpm	00.0 cpm	
U-2	2	Unit 2 - RATE / MAX Maximum Display	10.0 Mcpm		
U-2	3	Unit 2 - RATE / MAX Alarm 1	2.00 kcpm		
U-2	4	Unit 2 - RATE / MAX Alarm 2	5.00 kcpm		
U-2	5	Unit 2 - RATE / MAX Alarm 3	8.00 kcpm		
U-2	6	Unit 2 - COUNT Units and Minimum Display	000 c		
U-2	7	Unit 2 - COUNT Alarm 1	2.00 kc		
U-2	8	Unit 2 - COUNT Alarm 2	5.00 kc		
U-2	9	Unit 2 - COUNT Alarm 3	8.00 kc		
U-2	10	Unit 2 - DOSE Units and Minimum Display	0 (Disabled)		
U-2	11	Unit 2 - DOSE Alarm 1	2.00 kc		

Setting	#	Setup Parameter	Model 42-49	Model 42-49B	Internal Detector
U-2	12	Unit 2 - DOSE Alarm 2	5.00 kc		
U-2	13	Unit 2 - DOSE Alarm 3	8.00 kc		
U-2	14	Unit 2 - Channel	1		li

### 4.3 Entering Setup Mode

To enter Setup Mode, power on the instrument. Perform an extra-long press of the MODE button any time after power is applied up until 4 seconds after the main screen is displayed. This will allow the instrument to enter Setup mode; otherwise, setup enters lock-out mode.



If power is already applied, press and hold the ON/AUD button until the countdown begins and then release. This unlocks Setup mode and re-initializes the Setup mode, four-second lockout timer.



This process is different if you are in Sigma Audio Mode, rather than in the “click” Audio Mode. To enter Setup Mode with Sigma Mode enabled, once the power is applied, perform an extra-long press of the MODE button before the SIGMA background counter starts. Do not wait until the countdown is complete, which will prevent you from getting into the Setup Mode. There is no countdown for the “click” Audio Mode.

Entry to Setup Mode can be confirmed when the numeric portion of the display shows ‘dev,’ indicating the device setup page is selected. If you simply wish to view the parameters, short press the MODE button to advance forward through the parameters available on the selected Setup Page, short press the ON/AUD button to move backward through the parameters available, and short press UNIT to view the parameters of the currently selected Setup Page. An extra-long press of the UNIT button for three beeps will return to the previous page. To return to normal operation, repeat extra-long pressing and releasing of the UNIT button until all pages have been exited.



If the menu is not exited properly, any changes made will not be saved.

**SETUP PROTECT:** The Model 3007i parameters can be protected from unauthorized changes via the internal switch located on the Model 3007i circuit board. To change the switch, open the battery compartment and remove the batteries from the Model 3007i. Next, loosen the six pan-head screws that fasten the bottom cover.

Gently remove the bottom cover of the instrument. The DIP (dual in-line position) switch should now be visible in the center of the circuit board. With the instrument positioned as



indicated in the picture, slide dipswitch 2 towards the instrument handle.



The dipswitch has a plastic cover, which protects the switch during manufacturing. This plastic cover is left on the dipswitch after assembly and is not removed until the dipswitch is needed. If the plastic cover still remains on the dipswitch, please remove the cover before changing the switch settings.



Figure 4.1: Backlight/Setup Protect Dipswitch

There are four different options for protect mode, which can be set through the Lumic 2.0 Calibration Software. Locate the Parameter “Setup Prtct” in the Dev tab and select the desired option.

- **Normal:** All parameters are protected from change through the device menu. This is the default mode when the Setup Protect dipswitch is configured to the ON position.

- **Bypass Alarms:** All parameters except for Rate, Count, and Dose Alarms are protected from change through the device menu.

- **Bypass Alarms Count:** All parameters except for Rate Alarms, Count Alarms, Dose Alarms, and the User Defined Scaler Count Time are protected from change through the device menu.

- **Bypass All:** All parameters may be changed from the Setup Menu, similar to leaving the Setup Protect DIP Switch set to the OFF position.



With the DIP Switch 2 in the ON position, setup mode may be entered through the front panel, and any parameter which has not been bypassed may be viewed, but changes cannot be made. Only bypassed parameters may be changed.

**DISPLAY BACKLIGHT ‘Continuous On’:** The Model 3007i display backlight can be set to remain on continuously during operation. Follow the steps above for **SETUP PROTECT**, but use DIP Switch 1 for display backlight selection. Setting DIP Switch 1 to the ON (forward) position will configure the display backlight to remain on during operation. Set DIP Switch 1 to the OFF (back) position, and the display will be backlit only when light levels are low.



Setting the display backlight for continuous-on operation can result in reduced battery life. The backlight can be configured to always be off as well through the device menu or Lumatic 2.0 Calibration Software.

## 4.4 Setup Mode Operation

Once the Model 3007i is in Setup mode, setup page selection will be displayed on the LCD. Short press the MODE or ON/AUD button to choose the Setup Page you are interested in. Once the desired Setup Page is shown, short press the UNIT button to cycle down to the first parameter of that Setup Page. Further short presses on the MODE button will cycle down through the parameters for that page. Short press the ON/AUD button to cycle up through the parameters of that page. Extra-long-pressing the UNIT button will go back up to the Setup Page. Extra-long pressing again will exit the Setup Mode.

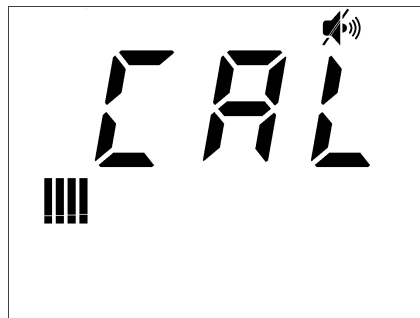

Figure 4.2: Setup Page Selection Display (showing page 4-CAL)

Extra-long-pressing the UNIT button, no matter what parameter is shown, will first return the user back to the Page Selection screen. An extra-long press of the UNIT button, when viewing the Page Selection screen, will save the setup data and return the instrument to normal operation.

When you get to a parameter that you want to change, short press the UNIT button. The display will begin flashing. This indicates the parameter can be changed. Use the MODE or ON/AUD buttons to make the change. If numbers are displayed on the parameter, the

MODE button will increment the numbers and ON/AUD will decrement the numbers. Otherwise, the MODE and ON/AUD button will cycle through the available settings. When you have adjusted the parameter setting to your desired number or setting, extra-long press the UNIT button. This will save the change and send you back up one screen to the page parameters. Finally, when viewing a Setup Page that is the same for multiple detectors in the Model 3007i, but each detector requires a different value, pressing the DETECTOR button until the appropriate detector LED is illuminated will allow the user to see and change the value for the selected detector. **For example: Set Detector 1, Rate Mode, Unit 1, Alarm 1 Value to 150 mR/h.** Enter the Setup Menu. Use the MODE or ON/AUD buttons to advance to U-1. Press the UNIT button to enter the menu. In the Model 3007i, if the appropriate DETECTOR LED is not lit, short press the DETECTOR button to cycle through the detectors until the appropriate LED is lit. Press the MODE button to get to the third of the 14 menu items. This is the parameter setting for the "RATE/MAX ALARM 1." Press the UNIT button to edit the value. The ones digit should begin flashing. Press the UNIT button to advance to the tens digit. Press the MODE button to increment the value to 5. Press the UNIT button to advance to the hundreds digit. Press the MODE button to increment the value to 1. Press the UNIT button to advance to the multiplier. (All digits, multiplier, and units will flash.) Press the MODE button to increase the multiplier until the display shows 150 (no decimal) and the units multiplier has advanced to mR/h. Press the UNIT button for 2 seconds to close setting. Press the UNIT button for 2 seconds to return to the page selection menu. Press the UNIT button for 2 seconds to exit Setup.

The list below shows the setup pages and the parameters in order, on each page.

## 4.5 Model 3007i List of Parameters (in order)

Page 1 - dev

- Multi-level Audio
- Backlight Threshold
- Auto Shutdown Time
- AuxCOM Communication Mode
- AuxCOM Power Mode
- AuxCOM Auto Mode Interval
- Real Time Clock Month
- Real Time Clock Day
- Real Time Clock Year
- Real Time Clock Hour
- Real Time Clock Minute

- Real Time Clock Second

Page 2 - Log

- Enabled
- Mode
- Location Mode 3
- Mode 3 Timer

Page 3 - Cfg

- Detector Enable
- Operation Modes
- Bar Graph Mode
- Response Rate
- Response Time
- Background Audio
- Background Alarms
- Audio Mode

Page 4 - CAL

- High Voltage Setpoint
- Calibration Constant Mantissa
- Calibration Constant Exponent
- Dead Time Correction 1
- Dead Time Correction 2 Mantissa
- Dead Time Correction 2 Exponent
- Detector Current Overload Threshold
- Detector Adjustable Scaler Count Time
- Detector Active Area

Page 5 - CH\_1

- Channel 1 - Threshold
- Channel 1 - Window
- Channel 1 - Efficiency
- Channel 1 - Loss of Count Alarm Time
- Channel 1 - Icon

Page 6 - U-1

- Unit 1 - RATE/MAX Units and Minimum Display
- Unit 1 - RATE/MAX Maximum Display
- Unit 1 - RATE/MAX Alarm 1
- Unit 1 - RATE/MAX Alarm 2
- Unit 1 - RATE/MAX Alarm 3
- Unit 1 - COUNT Units and Minimum Display
- Unit 1 - COUNT Alarm 1
- Unit 1 - COUNT Alarm 2
- Unit 1 - COUNT Alarm 3
- Unit 1 - DOSE Units and Minimum Display
- Unit 1 - DOSE Alarm 1
- Unit 1 - DOSE Alarm 2
- Unit 1 - DOSE Alarm 3
- Unit 1 - Channel

Page 7 - U-2

- Unit 2 - RATE/MAX Units and Minimum Display
- Unit 2 - RATE/MAX Maximum Display
- Unit 2 - RATE/MAX Alarm 1
- Unit 2 - RATE/MAX Alarm 2
- Unit 2 - RATE/MAX Alarm 3
- Unit 2 - COUNT Units and Minimum Display

- Unit 2 - COUNT Alarm 1
- Unit 2 - COUNT Alarm 2
- Unit 2 - COUNT Alarm 3
- Unit 2 - DOSE Units and Minimum Display
- Unit 2 - DOSE Alarm 1
- Unit 2 - DOSE Alarm 2
- Unit 2 - DOSE Alarm 3
- Unit 2 - Channel

Page 8 - rst

- Erase Storage (WARNING!!!)

## 4.6 Page 1 - Device

To begin adjusting a device parameter, short press the MODE or ON/AUD to scroll through the available device parameters. Next, short press UNIT to begin modifying the parameter chosen. Finally, extra-long pressing the UNIT button will complete the modification. Default settings are in bold.

**Multi-level Audio** - Upon entry into Multi-level Audio, the parameter will be selected (flashing) indicating the state of the parameter.

- **on (audio selection: off/low/med/high)**
- off (audio selection: off/on)

Use the MODE and ON/AUD buttons to scroll through the available parameter options.

**Backlight Threshold** - Upon entry into the Backlight Threshold, the parameter will be selected (flashing) indicating the state of the parameter.

- off (backlight off)
- lo (backlight low)
- hi (backlight high)
- **aut (backlight auto adjusts to light conditions)**

Use the MODE and ON/AUD buttons to scroll through the available parameter options.

**Auto Shutdown Time** - Upon entry into Auto Shutdown Time, the parameter will be selected (flashing).

- **00** - 12 (hours until auto shutdown where **0 is off**)

Use the MODE and ON/AUD buttons to scroll through the parameter options.

**AuxCOM Communication Mode**- Upon entry into AuxCOM Communication Mode, the parameter will be selected (flashing).

- **SLU** - SLURM is primarily for Bluetooth usage
- **dir** - LMI Direct communication (same format used by Lumic 2 software)
- **raw** (seen as rau with line over u to indicate w) - raw uncorrected count since last report
- **cPm** (seen as cPn with line over n to indicate m) - current CPM value regardless of units on LCD
- **dSP** - currently LCD displayed value, multiplier, and units

Use the MODE and ON/AUD buttons to scroll through the parameter options.

**AuxCOM Power Mode** - Upon entry into AuxCOM Power Mode, the parameter will be selected (flashing).

- **hot** - Hot indicates initial activation of Auxiliary communications is through the use of the hot key sequence.
- **abt** - At boot, Auxiliary communications are enabled and can be disabled using the hot key.

Use the MODE and ON/AUD buttons to scroll through the parameter options.

**AuxCOM Auto Mode Interval** - Upon entry into AuxCOM Auto Mode Interval, the parameter will be selected (flashing).

- **000** - 255 (seconds between reports where **0 is 1/4 second**)

Use the MODE and ON/AUD buttons to scroll through the parameter options.

**Real Time Clock Month** - Upon entry into Real Time Clock Month, the parameter will be selected (flashing).

- 01 - 12 (month of the year)

Use the MODE and ON/AUD buttons to scroll through the parameter options.

**Real Time Clock Day** - Upon entry into Real Time Clock Day, the parameter will be selected (flashing).

- 01 - 31 (day of the month)

Use the MODE and ON/AUD buttons to scroll through the parameter options.

**Real Time Clock Year** - Upon entry into Real Time Clock Year, one of the following parameters will be selected (flashing).

- Ones Place (0-9)
- Tens Place (0-9)
- Hundreds Place (0-9)

Thousands place is assumed to be two (for 2000). Use the UNIT button to select the appropriate parameter and use the MODE and ON/AUD buttons to scroll through the parameter options.

**Real Time Clock Hour** - Upon entry into Real Time Clock Hour, the parameter will be selected (flashing).

- 01 - 23 (hours of the day)

Use the MODE and ON/AUD buttons to scroll through the parameter options.

**Real Time Clock Minute** - Upon entry into Real Time Clock Minute, the parameter will be selected (flashing).

- 00 - 59 (minutes of the hour)

Use the MODE and ON/AUD buttons to scroll through the parameter options.

**Real Time Clock Second** - Upon selection of Real Time Clock Seconds, the seconds displayed on the LCD will continue to increment. Upon entry into Real Time Clock Seconds, the parameter will be frozen as well as selected (flashing).

- 00 - 59 (seconds of the minute)



Use the MODE and ON/AUD buttons to scroll through the parameter options. Please note that when exiting the parameter, even if no changes were made, the seconds parameter will automatically be reassigned the frozen value.

## 4.7 Page 2 - Datalogging

To begin adjusting a device parameter, short press the MODE and ON/AUD to scroll through the available device parameters. To begin, short press UNIT to begin modifying the parameter chosen. Finally, extra-long pressing the UNIT button will complete the modification. Default settings are in bold.

**Enabled** - Upon entry into Enabled, the parameter will be selected (flashing) indicating the state of the parameter.

- on (datalogging is enabled)
- **off (datalogging is disabled)**

Use the MODE and ON/AUD buttons to scroll through the available parameter options.

**Mode** - Upon entry into Mode, the parameter will be selected (flashing) indicating the state of the parameter.

- **01 (log data, uses the first Location ID)**
- 02 (log data, user selectable Location ID)
- 03 (auto log data, user-defined log interval and Location ID)

Use the MODE and ON/AUD buttons to scroll through the available parameter options.

**Location Mode 3** - Upon entry into Location Mode 3, the parameter will be selected (flashing) indicating the state of the parameter.

- **01-250** - (Location ID for Mode 3)

Use the MODE and ON/AUD buttons to scroll through the available parameter options.

**Mode 3 Timer** - Upon entry into Location ID, the parameter will be selected (flashing) indicating the state of the parameter.

- **1** - 1.8K (number of seconds between data log events)

Use the MODE and ON/AUD buttons to scroll through the available parameter options.

## 4.8 Page 3 - Configuration

To begin adjusting a device parameter, short press the MODE or ON/AUD to scroll through the available device parameters. In the Model 3007i, when the appropriate parameter is selected, short press DETECTOR to select the detector that needs the parameter adjusted. To begin, short press UNIT to begin modifying the parameter chosen. Finally, extra-long pressing the UNIT button will complete the modification. Default settings are in bold.

**Detector Enable** - Upon entry into Detector Enabled, the parameter will be selected (flashing) indicating the state of the parameter.

- **on (detector is enabled)**
- off (detector is disabled)

Use the MODE and ON/AUD buttons to scroll through the available parameter options.

**Operation Modes** - Upon entry into Operation Modes, the parameter will be selected (flashing) indicating the state of the parameter. A picture of the LCD is below.

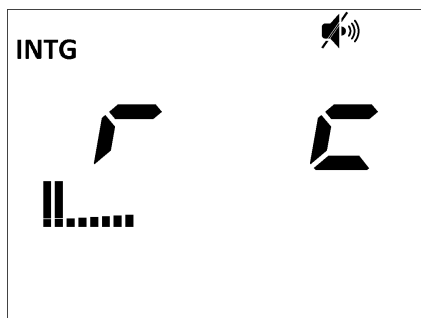

Figure 4.3: Detector Operation Modes

Each mode is represented on the LCD screen as follows:

- r - rate mode
- c - count mode (scaler)
- MAX - MAX mode
- INTG - integrated dose mode (only enabled for internal detectors by default)

Use the MODE and ON/AUD buttons to scroll through the available parameter options while noting that at least one operational mode must be enabled for each active detector. If no modes were enabled rate mode will automatically be enabled for external detectors, and dose mode will be enabled for internal detectors.

**Bar Graph Mode** - Upon entry into Bar Graph Mode, the parameter will be selected (flashing) indicating the state of the parameter.

- off (no bar graphing)
- **Std (standard bar graphing mode - decade)**
- Ful (full bar graphing mode from 0 to max display)
- A-1 (bar graphing from 0 to alarm 1)
- A-2 (bar graphing from 0 to alarm 2)
- A-3 (bar graphing from 0 to alarm 3)
- log (bar graphing as a log scale)

Use the MODE and ON/AUD buttons to scroll through the available parameter options.

**Response Rate** - Upon entry into Response Rate, the parameter will be selected (flashing) indicating the state of the parameter.

- USr (user-defined time)
- A-S (auto slow)
- F-S (fixed slow at 22 seconds)
- A-F (auto fast)
- **F-F (fixed fast at 4 seconds)**

Use the MODE and ON/AUD buttons to scroll through the available parameter options.

**Response Time** - Upon entry into the user-defined Response Time, the parameter will be selected (flashing) indicating the state of the parameter.

- 1 - 60 (response time in seconds from 10% of old reading to 90% of new reading)

Use the MODE and ON/AUD buttons to scroll through the available parameter options.

**Background Audio** - Upon entry into Background Audio, the parameter will be selected (flashing) indicating the state of the parameter.

- on (background audio is enabled)
- **off (background audio is disabled)**

Use the MODE and ON/AUD buttons to scroll through the available parameter options. When background audio is enabled it applies only to the external detector it was enabled for, and the primary and secondary units must use different channels. For example: alpha beta configurations utilize both channels so when enabled both alpha and beta click audio can be heard all the time.

**Background Alarms** - Upon entry into Background Alarms, the parameter will be selected (flashing) indicating the state of the parameter.

- on (background alarms are enabled)
- **off (background alarms are disabled)**

Use the MODE and ON/AUD buttons to scroll through the available parameter options.

**Audio Mode**- Upon entry into Audio Mode, the parameter will be selected (flashing) indicating the state of the parameter.

- Sig (Sigma audio)
- **clc (Click audio is enabled)**

Use the MODE and ON/AUD buttons to scroll through the available parameter options.

## 4.9 Page 4 - Calibration

To begin adjusting a calibration parameter, short press the MODE or ON/AUD to scroll through the available calibration parameters. If in the Model 3007i, when the appropriate parameter is selected, short press DETECTOR to select the detector that needs the parameter adjusted. To begin, short press UNIT to begin modifying the parameter chosen. Finally, extra-long pressing the UNIT button will complete the modification.

**High Voltage** - Upon entry into High Voltage, one of the following parameters will be selected (flashing).

- Ones Place (0-9)
- Tens Place (0-9)
- Hundreds Place (0-9)
- $\mu/k$  Multiplier with all digits flashing (on/off)

Use the UNIT button to select the appropriate parameter, and use the MODE and ON/AUD buttons to scroll through the parameter options.



The k multiplier also activates left-most decimal point. If k multiplier is used, Hundreds Place becomes the Thousands Place, Tens Place becomes the Hundreds Place, and Ones Place becomes the Tens Place.

**Calibration Constant Mantissa** - Upon entry into Calibration Constant Mantissa, one of the following parameters will be selected (flashing).

- Ones Place (0-9)
- Tens Place (0-9)
- Hundreds Place (0-9)

Use the UNIT button to select the appropriate parameter, and use the MODE and ON/AUD buttons to scroll through the parameter options.

**Calibration Constant Exponent** - Upon entry into Calibration Constant Exponent, one of the following parameters will be selected (flashing).

- Ones Place (0-9)
- Tens Place (0-9)

Use the UNIT button to select the appropriate parameter, and use the MODE and ON/AUD buttons to scroll through the parameter options.

**Dead Time Correction 1** - Upon entry into Dead Time Correction, one of the following parameters will be selected (flashing).

- Rightmost Digit (0-9)
- Middle Digit (0-9)
- Leftmost digit (0-9)
- $\mu$ /m multiplier with all digits flashing (adjustable from x.xx  $\mu$  to x.xx m)

Use the UNIT button to select the appropriate parameter, and use the MODE and ON/AUD buttons to scroll through the parameter options.

**Dead Time Correction 2 Mantissa** - Upon entry into Dead Time Correction 2 Mantissa, one of the following parameters will be selected (flashing).

- Ones Place (0-9)
- Tens Place (0-9)

- Hundreds Place (0-9)

Use the UNIT button to select the appropriate parameter and use the MODE and ON/AUD buttons to scroll through the parameter options.

**Dead Time Correction 2 Exponent** - Upon entry into Dead Time Correction 2 Exponent, the exponent will be flashing.

- Exponent (-6 to -15)

Use the MODE and ON/AUD buttons to scroll through the parameter options.

**Detector Current Overload Threshold** - Upon entry into Detector Current Overload Threshold, one of the following parameters will be selected (flashing).

- Rightmost Digit (0-9)
- Middle Digit (0-9)
- Leftmost digit (0-9)
- $\mu/m/<>$  Multiplier with all digits flashing (adjustable from  $x.xx \mu$  to  $x.xx$ )

Use the UNIT button to select the appropriate parameter, and use the MODE and ON/AUD buttons to scroll through the parameter options.

Perform an extra-long press of the DETECTOR button to view the live current draw of the active detector. Performing an extra-long press of the DETECTOR button again will return to the set point value.

**Detector Adjustable Scaler Count Time** - Upon entry into Detector Adjustable Scaler Count Time, one of the following parameters will be selected (flashing).

- Rightmost Digit (0-9)
- Middle Digit (0-9)
- Leftmost digit (0-9)
- $<>/k/M$  Multiplier with all digits flashing (adjustable from  $xxx$  to  $xxx M$ )

Use the UNIT button to select the appropriate parameter, and use the MODE and ON/AUD buttons to scroll through the parameter options.

**Detector Active Area** - Upon entry into Detector Active Area, one of the following parameters will be selected (flashing).

- Rightmost Digit (0-9)
- Middle Digit (0-9)
- Leftmost digit (0-9)
- Multiplier with all digits flashing (adjustable from x.xx to xxx)

Use the UNIT button to select the appropriate parameter, and use the MODE and ON/AUD buttons to scroll through the parameter options.

## 4.10 Page 5 - Channel 1

To begin adjusting a channel parameter, short press the MODE or ON/AUD to scroll through the available channel parameters. In the Model 3007i, when the appropriate parameter is selected, short press DETECTOR to select the detector that needs the parameter adjusted.

To begin, short press UNIT to begin modifying the parameter chosen. Finally, extra-long pressing the UNIT button will complete the modification.

**Channel 1 - Threshold** - Upon entry into Channel 1 Threshold, one of the following parameters will be selected (flashing).

- Rightmost Digit (0-9)
- Middle Digit (0-9)
- Leftmost Digit (0-9)
- Multiplier (m) with all digits flashing (adjustable from x.xx m to xxx m)

Use the UNIT button to select the appropriate parameter, and use the MODE and ON/AUD buttons to scroll through the parameter options.

**Channel 1 - Window** - Upon entry into Channel 1 Window, one of the following parameters will be selected (flashing).

- Rightmost Digit (0-9)
- Middle Digit (0-9)
- Leftmost Digit (0-9)
- Multiplier (m) with all digits flashing (adjustable from x.xx m to xxx m)

Use the UNIT button to select the appropriate parameter, and use the MODE and ON/AUD buttons to scroll through the parameter options.

**Channel 1 – Efficiency (%)** - Upon entry into Channel 1 Efficiency, one of the following parameters will be selected (flashing).

- Rightmost Digit (0-9)
- Middle Digit (0-9)
- Leftmost Digit (0-9)
- Multiplier (m/<>) with all digits flashing (adjustable from xxx m to xxx)

Use the UNIT button to select the appropriate parameter, and use the MODE and ON/AUD buttons to scroll through the parameter options.

**Channel 1 - Loss of Count Alarm Time** - Upon entry into Channel 1 Loss of Count Time, one of the following parameters will be selected (flashing).

- Ones Place (0-9)
- Tens Place (0-9)
- Hundreds Place (0-9)

Use the UNIT button to select the appropriate parameter, and use the MODE and ON/AUD buttons to scroll through the parameter options.

**Channel 1 - Icon** - Upon entry into Channel 1 Icon, one of the following parameters will be selected (flashing).

- $\alpha$  – Alpha icon
- $\beta$  – Beta icon
- $\gamma$  – Gamma icon
- n - Neutron icon
- $\alpha + \beta$
- $\alpha + \gamma$
- $\beta + \gamma$
- $\alpha, \beta, \& \gamma$
- $\alpha + n$



- $\beta + n$
- $\alpha, \beta, \& n$
- $\gamma + n$
- $\alpha, \gamma, \& n$
- $\beta, \gamma, \& n$
- $\alpha, \beta, \gamma, \& n$
- OFF – No icon

Use the MODE and ON/AUD buttons to scroll through the available parameter options.

## 4.11 Page 6 - Unit 1

To begin adjusting a unit parameter, short press the MODE or ON/AUD to scroll through the available unit parameters. In the Model 3007i, when the appropriate parameter is selected, short press DETECTOR to select the detector that needs the parameter adjusted. To begin, short press UNIT to begin modifying the parameter chosen. Finally, extra-long pressing the UNIT button will complete the modification.

**Unit 1 - RATE/MAX Units and Minimum Display** - Upon entry into Unit 1 RATE/MAX Units and Minimum Display, one of the following parameters will be selected (flashing). **Note:** Select Unit first before setting other parameters.

- Rightmost Digit (0-9)
- Middle Digit (0-9)
- Leftmost Digit (0-9)
- Multiplier with all digits flashing (adjustable from  $x.xx \mu$  to  $x.xx k$ )
- Unit (off, dpm, Bq, Bq/cm, cpm, cps, Rem/h, R/hr, Sv/h)

Use the UNIT button to select the appropriate parameter, and use the MODE and ON/AUD buttons to scroll through the parameter options.

**Unit 1 - RATE/MAX Maximum Display** - Upon entry into Unit 1 RATE/MAX Units Maximum Display, one of the following parameters will be selected (flashing).

- Rightmost Digit (0-9)
- Middle Digit (0-9)
- Leftmost Digit (0-9)

- Multiplier with all digits flashing (adjustable from  $x.xx \mu$  to  $x.xx k$ )

Use the UNIT button to select the appropriate parameter, and use the MODE and ON/AUD buttons to scroll through the parameter options.

**Unit 1 - RATE/MAX Alarm 1** - Upon entry into Unit 1 RATE/MAX Alarm 1, one of the following parameters will be selected (flashing).

- Rightmost Digit (0-9)
- Middle Digit (0-9)
- Leftmost Digit (0-9)
- Multiplier with all digits flashing (adjustable from  $x.xx \mu$  to  $xxx M$  depending on unit selected)

Use the UNIT button to select the appropriate parameter, and use the MODE and ON/AUD buttons to scroll through the parameter options.

**Unit 1 - RATE/MAX Alarm 2** - Upon entry into Unit 1 RATE/MAX Alarm 2, one of the following parameters will be selected (flashing).

- Rightmost Digit (0-9)
- Middle Digit (0-9)
- Leftmost Digit (0-9)
- Multiplier with all digits flashing (adjustable from  $x.xx \mu$  to  $xxx M$  depending on unit selected)

Use the UNIT button to select the appropriate parameter, and use the MODE and ON/AUD buttons to scroll through the parameter options.

**Unit 1 - RATE/MAX Alarm 3** - Upon entry into Unit 1 RATE/MAX Alarm 3, one of the following parameters will be selected (flashing).

- Rightmost Digit (0-9)
- Middle Digit (0-9)
- Leftmost Digit (0-9)
- Multiplier with all digits flashing (adjustable from  $x.xx \mu$  to  $xxx M$  depending on unit selected)

Use the UNIT button to select the appropriate parameter, and use the MODE and ON/AUD buttons to scroll through the parameter options.

**Unit 1 - COUNT Units and Minimum Display** - Upon entry into Unit 1 Count Units Minimum Display, one of the following parameters will be selected (flashing). **Note:** Select Unit first before selecting multiplier.

- Multiplier with all digits flashing (adjustable from  $x.xx \mu$  to xxx M depending on unit selected)
- Unit (off, d, dpm, Bq, Bq/cm<sup>2</sup>, c, cps, cpm, Rem, Rem/h, R, R/h, Sv, Sv/h)

Use the UNIT button to select the appropriate parameter, and use the MODE and ON/AUD buttons to scroll through the parameter options.

**Unit 1 - COUNT Alarm 1** - Upon entry into Unit 1 Count Alarm 1, one of the following parameters will be selected (flashing).

- Rightmost Digit (0-9)
- Middle Digit (0-9)
- Leftmost Digit (0-9)
- Multiplier with all digits flashing (adjustable from  $x.xx \mu$  to xxx M depending on unit selected)

Use the UNIT button to select the appropriate parameter, and use the MODE and ON/AUD buttons to scroll through the parameter options.

**Unit 1 - COUNT Alarm 2** - Upon entry into Unit 1 Count Alarm 2, one of the following parameters will be selected (flashing).

- Rightmost Digit (0-9)
- Middle Digit (0-9)
- Leftmost Digit (0-9)
- Multiplier with all digits flashing (adjustable from  $x.xx \mu$  to xxx M depending on unit selected)

Use the UNIT button to select the appropriate parameter, and use the MODE and ON/AUD buttons to scroll through the parameter options.

**Unit 1 - COUNT Alarm 3** - Upon entry into Unit 1 Count Alarm 3, one of the following parameters will be selected (flashing).

- Rightmost Digit (0-9)
- Middle Digit (0-9)
- Leftmost Digit (0-9)
- Multiplier with all digits flashing (adjustable from x.xx  $\mu$  to xxx M depending on unit selected)

Use the UNIT button to select the appropriate parameter, and use the MODE and ON/AUD buttons to scroll through the parameter options.

**Unit 1 - DOSE Units and Minimum Display** - Upon entry into Unit 1 RATE/MAX Units Maximum Display, one of the following parameters will be selected (flashing). **Note:** Select Unit first before selecting multiplier.

- Multiplier with all digits flashing (adjustable from x.xx  $\mu$  to xxx M depending on unit selected)
- Unit (off, d, c, Rem, R, Sv)

Use the UNIT button to select the appropriate parameter, and use the MODE and ON/AUD buttons to scroll through the parameter options.

**Unit 1 - DOSE Alarm 1** - Upon entry into Unit 1 Dose Alarm 1, one of the following parameters will be selected (flashing).

- Rightmost Digit (0-9)
- Middle Digit (0-9)
- Leftmost Digit (0-9)
- Multiplier with all digits flashing (adjustable from x.xx  $\mu$  to xxx M depending on unit selected)

Use the UNIT button to select the appropriate parameter, and use the MODE and ON/AUD buttons to scroll through the parameter options.

**Unit 1 - DOSE Alarm 2** - Upon entry into Unit 1 Dose Alarm 2, one of the following parameters will be selected (flashing).

- Rightmost Digit (0-9)
- Middle Digit (0-9)
- Leftmost Digit (0-9)

- Multiplier with all digits flashing (adjustable from x.xx  $\mu$  to xxx M depending on unit selected)

Use the UNIT button to select the appropriate parameter, and use the MODE and ON/AUD buttons to scroll through the parameter options.

**Unit 1 - DOSE Alarm 3** - Upon entry into Unit 1 Dose Alarm 3, one of the following parameters will be selected (flashing).

- Rightmost Digit (0-9)
- Middle Digit (0-9)
- Leftmost Digit (0-9)
- Multiplier with all digits flashing (adjustable from x.xx  $\mu$  to xxx M depending on unit selected)

Use the UNIT button to select the appropriate parameter, and use the MODE and ON/AUD buttons to scroll through the parameter options.

**Unit 1 - Channel** - Upon entry into Unit 1 Channel, the parameter will be selected (flashing) indicating the state of the parameter. Valid parameter options are as follows:

- 1 (Channel 1)
- 2 (Channel 2)
- 1i (Internal Detector Only)

Use the MODE and ON/AUD buttons to scroll through the parameter options.

## 4.12 Page 7 - Unit 2

To begin adjusting a unit parameter, short press the MODE or ON/AUD to scroll through the available unit parameters. If in the Model 3007i, when the appropriate parameter is selected, short press DETECTOR to select the detector that needs the parameter adjusted. To begin, short press UNIT to begin modifying the parameter chosen. Finally, extra-long pressing the UNIT button will complete the modification.

**Unit 2 - RATE/MAX Units and Minimum Display** - Upon entry into Unit 2 RATE/MAX Units and Minimum Display, one of the following parameters will be selected (flashing). **Note:** Select Unit first before setting other parameters.

- Rightmost Digit (0-9)

- Middle Digit (0-9)
- Leftmost digit (0-9)
- Multiplier with all digits flashing (adjustable from x.xx  $\mu$  to x.xx k)
- Unit (off, dpm, Bq, Bq/cm, cpm, cps, Rem/h, R/h, Sv/h)

Use the UNIT button to select the appropriate parameter, and use the MODE and ON/AUD buttons to scroll through the parameter options.

**Unit 2 - RATE/MAX Maximum Display** - Upon entry into Unit 2 RATE/MAX Units Maximum Display, one of the following parameters will be selected (flashing).

- Rightmost Digit (0-9)
- Middle Digit (0-9)
- Leftmost Digit (0-9)
- Multiplier with all digits flashing (adjustable from x.xx  $\mu$  to x.xx k)

Use the UNIT button to select the appropriate parameter, and use the MODE and ON/AUD buttons to scroll through the parameter options.

**Unit 2 - RATE/MAX Alarm 1** - Upon entry into Unit 2 RATE/MAX Alarm 1, one of the following parameters will be selected (flashing).

- Rightmost Digit (0-9)
- Middle Digit (0-9)
- Leftmost Digit (0-9)
- Multiplier with all digits flashing (adjustable from x.xx  $\mu$  to xxx M depending on unit selected)

Use the UNIT button to select the appropriate parameter, and use the MODE and ON/AUD buttons to scroll through the parameter options.

**Unit 2 - RATE/MAX Alarm 2** - Upon entry into Unit 2 RATE/MAX Alarm 2, one of the following parameters will be selected (flashing).

- Rightmost Digit (0-9)
- Middle Digit (0-9)
- Leftmost Digit (0-9)

- Multiplier with all digits flashing (adjustable from x.xx  $\mu$  to xxx M depending on unit selected)

Use the UNIT button to select the appropriate parameter, and use the MODE and ON/AUD buttons to scroll through the parameter options.

**Unit 2 - RATE/MAX Alarm 3** - Upon entry into Unit 2 RATE/MAX Alarm 3, one of the following parameters will be selected (flashing).

- Rightmost Digit (0-9)
- Middle Digit (0-9)
- Leftmost Digit (0-9)
- Multiplier with all digits flashing (adjustable from x.xx  $\mu$  to xxx M depending on unit selected)

Use the UNIT button to select the appropriate parameter, and use the MODE and ON/AUD buttons to scroll through the parameter options.

**Unit 2 - COUNT Units and Minimum Display** - Upon entry into Unit 2 Count Units Minimum Display, one of the following parameters will be selected (flashing). **Note:** Select Unit first before selecting multiplier.

- Multiplier with all digits flashing (adjustable from x.xx  $\mu$  to xxx M depending on unit selected)
- Unit (off, d, dpm, Bq, Bq/cm<sup>2</sup>, c, cps, cpm, Rem, Rem/h, R, R/h, Sv, Sv/h)

Use the UNIT button to select the appropriate parameter, and use the MODE and ON/AUD buttons to scroll through the parameter options.

**Unit 2 - COUNT Alarm 1** - Upon entry into Unit 2 Count Alarm 1, one of the following parameters will be selected (flashing).

- Rightmost Digit (0-9)
- Middle Digit (0-9)
- Leftmost Digit (0-9)
- Multiplier with all digits flashing (adjustable from x.xx  $\mu$  to xxx M depending on unit selected)

Use the UNIT button to select the appropriate parameter, and use the MODE and ON/AUD buttons to scroll through the parameter options.

**Unit 2 - COUNT Alarm 2** - Upon entry into Unit 2 Count Alarm 2, one of the following parameters will be selected (flashing).

- Rightmost Digit (0-9)
- Middle Digit (0-9)
- Leftmost Digit (0-9)
- Multiplier with all digits flashing (adjustable from x.xx  $\mu$  to xxx M depending on unit selected)

Use the UNIT button to select the appropriate parameter, and use the MODE and ON/AUD buttons to scroll through the parameter options.

**Unit 2 - COUNT Alarm 3** - Upon entry into Unit 2 Count Alarm 3, one of the following parameters will be selected (flashing).

- Rightmost Digit (0-9)
- Middle Digit (0-9)
- Leftmost Digit (0-9)
- Multiplier with all digits flashing (adjustable from x.xx  $\mu$  to xxx M depending on unit selected)

Use the UNIT button to select the appropriate parameter, and use the MODE and ON/AUD buttons to scroll through the parameter options.

**Unit 2 - DOSE Units and Minimum Display** - Upon entry into Unit 2 RATE/MAX Units Maximum Display, one of the following parameters will be selected (flashing). **Note:** Select Unit first before selecting multiplier.

- Multiplier with all digits flashing (adjustable from x.xx  $\mu$  to xxx M depending on unit selected)
- Unit (off, d, c, Rem, R, Sv)

Use the UNIT button to select the appropriate parameter, and use the MODE and ON/AUD buttons to scroll through the parameter options.

**Unit 2 - DOSE Alarm 1** - Upon entry into Unit 2 Dose Alarm 1, one of the following parameters will be selected (flashing).



- Rightmost Digit (0-9)
- Middle Digit (0-9)
- Leftmost Digit (0-9)
- Multiplier with all digits flashing (adjustable from x.xx  $\mu$  to xxx M depending on unit selected)

Use the UNIT button to select the appropriate parameter, and use the MODE and ON/AUD buttons to scroll through the parameter options.

**Unit 2 - DOSE Alarm 2** - Upon entry into Unit 2 Dose Alarm 2, one of the following parameters will be selected (flashing).

- Rightmost Digit (0-9)
- Middle Digit (0-9)
- Leftmost Digit (0-9)
- Multiplier with all digits flashing (adjustable from x.xx  $\mu$  to xxx M depending on unit selected)

Use the UNIT button to select the appropriate parameter, and use the MODE and ON/AUD buttons to scroll through the parameter options.

**Unit 2 - DOSE Alarm 3** - Upon entry into Unit 2 Dose Alarm 3, one of the following parameters will be selected (flashing).

- Rightmost Digit (0-9)
- Middle Digit (0-9)
- Leftmost Digit (0-9)
- Multiplier with all digits flashing (adjustable from x.xx  $\mu$  to xxx M depending on unit selected)

Use the UNIT button to select the appropriate parameter, and use the MODE and ON/AUD buttons to scroll through the parameter options.

**Unit 2 - Channel** - Upon entry into Unit 2 Channel, the parameter will be selected (flashing) indicating the state of the parameter. Valid parameter options are as follows:

- 1 (Channel 1)
- 2 (Channel 2)

- li (Internal Detector Only)

Use the MODE and ON/AUD buttons to scroll through the parameter options.

### **4.13 Page 8 - Reset (WARNING!!!)**

In the event of an instrument issue that requires major modification to the stored instrument values, an instrument reset has been incorporated, which will wipe out all stored information in the device with the exception of hardware calibration information from the factory. This reset is password protected, and the password will only be provided by the factory should it be required.

## DATALOGGING

The datalogging feature of the Model 3007i accessible through the use of the optional Lumic Datalogger software kit, allows the user to log radiation readings with the use of a handle-mounted LOG button. Data can be logged in any of the Model 3007i's operational modes (RATE, MAX, and COUNT). Up to 1000 data points can be taken and stored internally. Depending on the chosen Datalogging Mode, the user can quickly save logged data using a single Location ID, or select from up to 250 stored Location IDs. A Real Time Clock (RTC) is utilized to time and date stamp each datalog entry.

The saved log data and stored location IDs can be viewed, downloaded, and erased using the LMI Lumic Datalogger software kit, which includes a USB cable. Editing of datalogging parameters and RTC via setup mode on the instrument is disabled.

Setup of the datalogging parameters is also done through the LMI Lumic Datalogger software. The advanced user or administrator can set:

- Datalogging Mode
- Real Time Clock (RTC) Values
- Location IDs

### 5.1 Datalogging Operation – Mode 1

Datalogging Mode 1 will store the logged data using only the first Location ID in the Location ID table.

- When the LOG button is pressed, the current radiation reading and other log data is saved along with the first Location ID in the format specified in the Specifications at the end of this section.
- In COUNT Mode:
  - With a set count time, the LOG button is disabled until completion of a Scaler count.

- For a continuous Scaler count (Scaler time is 0), the LOG button is enabled at all times.
- For approximately 2 seconds, the LCD will display the Datalog Table index for the newly saved log data.



Figure 5.1: Displaying Datalog Table Index of 12

- After displaying the Datalog Table index, the instrument will return to the previous mode of operation.
- The Datalog Table is linear; once the table is full, no further writes will be allowed until the Datalog Table is erased.
- If an attempt is made to write to a full Datalog Table, a 1/4 second audio alert will sound and the maximum Datalog Table index (1.00 k) will be displayed for about 2 seconds. The instrument will then return to the previous mode of operation.

## 5.2 Datalogging Operation – Mode 2

Datalogging Mode 2 will allow the user to choose the Location ID (by Location ID Table index) to store with the logged data.

- When the LOG button is pressed, the current radiation readings and other log data are temporarily stored.
- In COUNT Mode:
  - With a set count time, the LOG button is disabled until completion of a Scaler count.
  - For a continuous Scaler count (Scaler time is 0), the LOG button is enabled at all times.
- The LCD display will show a possible Location ID Table index for the user. The index will be auto-incremented from the previously used index.

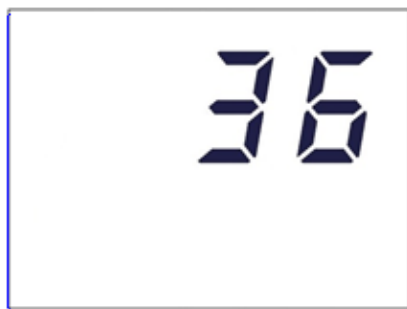

Figure 5.2: Displaying Datalog Location ID Table Index of 36

- The number will be blinking, indicating a changeable value. The user may then enter the preferred Location ID Table index by a short press of the MODE (to increment the value) or ON/AUD (to decrement the value) buttons as in Setup mode.
- Once the user has the preferred Location ID Table index entered, a short press of the LOG button will save the log data.
- After displaying the Datalog Table index, the instrument will return to the previous mode of operation.
- The Datalog Table is linear; once the table is full, a 1/4 second audio alert will sound and no further writes will be allowed until the Datalog Table is erased.

### 5.3 Datalogging Operation – Mode 3

Datalogging Mode 3 will automatically record data log records using the current location saved in Location Mode 3 with the user settable auto log interval, Mode 3 Timer, settable to record every 1 to 1800 seconds.

- When the Device is turned on and in RATE or MAX mode, the current radiation reading and other log data is recorded at the set interval.
- In SCALER Mode:
  - Auto log will be paused and will only log at the completion of each count.
  - For a continuous Scaler count (Scaler time is 0), logs will be recorded at auto log interval.
- If the auto log interval is greater than 5 seconds, the Datalog Table index will be displayed for approximately 2 seconds; otherwise, no visual indication will occur.
- The Datalog Table is linear; once the table is full, a 1/4 second audio alert will sound and no further writes will be allowed until the Datalog Table is erased.



A short press of the LOG button will start a count and automatically log the result. An extra-long press of the LOG button during the count will toggle the display between the timer and reading.

## 5.4 Format

The datalogging format is as follows:

- Format Version (1 Byte)
- Month (1 Byte)
- Year (2 Bytes)
- Day (1 Byte)
- Hour (1 Byte)
- Minutes (1 Byte)
- Seconds (1 Byte)
- Logged Value (4 Bytes)
- Range (1 Byte)
- Units (1 Byte)
- Mode (1 Byte)
- Detector Number (1 Byte)
- Status (1 Byte)
- Reserved (2 Bytes)
- Elapsed Count Time in seconds (4 Bytes)
- Scaler Count Time in seconds (4 Bytes)
- Location ID (32 Bytes)

## SOFTWARE

### 6.1 Connecting to Lumic 2.0 Calibration/Configuration Software

The optional Ludlum Lumic 2 Calibration/Configuration software is sent with a standard two-meter cable. (A five-meter cable can be provided if requested. However, any cable longer than two meters may have issues with some USB hubs and computers, typically laptops.)

To connect an instrument to the computer, please connect one end of the USB cable to the instrument first, and then the other end to the computer. Do not connect both ends to the computer.

Please allow Windows® a moment to install the proper HID drivers for the instrument before trying to use any software.



We recommend that you plug the USB cable into the back of your PC that connects to your motherboard instead of a USB hub.



Some parameters may only be edited in software, such as the backlight thresholds, COUNT Display Mode, COUNT Audio Mode, and Setup prtct.

Follow the Lumic 2.0 Calibration/Configuration software manual.





## ADVANCED FEATURES

### 7.1 Dead Time Correction

All pulse counting detectors have a “dead time” in which the detector is unable to register another event. In relatively low fields this is not an issue. However, as the field strength approaches the high end of the detector’s range, dead time causes the pulse rate to become non-linear with respect to the real radiation field. Dead time correction is used to linearize the measurements, allowing a wider linear response range for a given detector.

This instrument uses a second order dead time correction using the equation

$$rate_c = rate_m / [1 - (DTC_1 * rate_m) + (DTC_2 * rate_m^2)]$$

Where  $DTC_1$  and  $DTC_2$  are the dead time correction coefficients,  $rate_m$  is the measured count rate, and  $rate_c$  is the corrected rate.

Dead time correction coefficients are configured through the device setup menu or through Lumic Calibration software. Lumic Calibration software also includes a wizard that will automate finding and setting the correct coefficients.

$DTC_1$  is represented in microseconds ( $\mu$ s) on the device setup menu and in the software. The equation must be calculated in terms of seconds (s) and must be scaled appropriately.  $DTC_2$  has more complex units and are not shown. However, the representation of the coefficient on the setup menu and in software do not require scaling.



Setting the  $DTC_2$  to zero will disable the second order correction, while setting  $DTC_1$  to zero will disable both, regardless of the value of  $DTC_2$ .

### 7.2 Units

Depending on the chosen display units, different features will affect the value of the reading. The following table lists the features that apply to each of the display units.

Table 7.1: Features That Affect Units in All Modes

UNITS	Feature
cpm, cps, counts	Deadtime Correction
Bq, dpm, disintegrations	Deadtime Correction, Efficiency
Bq/cm <sup>3</sup>	Deadtime Correction, Efficiency, Active area
R/hr, R	Deadtime Correction, Calibration constant
Sv/h, Sv	Deadtime Correction, Calibration constant, R to Sv Conversion

### 7.3 R to Sv Conversion

The R to Sv conversion is a setting available in Lumatic Calibration software. It defines the conversion factor between R and Sv. Since the calibration constant is directly tied to R (counts per R), calibrating Sv requires a correct setting of both calibration constant and R to Sv conversion.

The rem unit is also affected by the R to Sv conversion. A rem is defined in firmware as being 100x the value of Sv.

Example: An R to Sv conversion factor of 0.0106 will cause a reading of 10.6 mSv/h (1.06 rem/h) while in a 1 R/h field.

### 7.4 Software Calibration Tools

Lumatic Calibration software includes wizards that will assist in calibrating and plateauing detectors. After configuring the wizard for a specific detector, the wizard will automate much of the data collection and calculation required for calibration.

### 7.5 Hardware Correction

This instrument provides the user with the ability to manually enter a voltage for both high voltage and threshold. To ensure that the voltage entered by the user produces a proper high voltage or threshold voltage that is within instrument tolerances, the instrument is adjusted at the factory during manufacturing. As a result, adjustment of any parameters visible in the DevCal menu of the Lumatic 2 software is not required and should not be adjusted in the field. However, if hardware correction is required (due to board rework, etc.) the hardware correction settings are available in Lumatic 2 Calibration software on the DevCal tab.

## 7.6 Other Device Data

The following parameters on the instrument allow recording import device information within the device:

**Firmware Version:** This is a read-only presentation of the firmware version. With a firmware version of Ex.y.zzzz, the Ex.y will show up on the device screen during the power-on sequence and signifies the released version.

**Device – Model Name:** This should match the model name on the front face of the instrument.

**Device – Serial Number:** This should match the serial number of the instrument.

**Detector – Model:** This can store the model of the detectors the instrument was calibrated for.

**Detector – Serial Number:** This can store the serial number of the detectors the instrument was calibrated for.

## 7.7 Battery Life

The instrument leaves the shop with adjustments to meet most consumer demands; however, advanced users may use the Lumic software to adjust the LED and backlight brightness to maximize battery life. By changing the backlight mode of operation and adjusting the brightness settings for the backlight and LED to meet user needs, it is possible to reduce battery current consumption by as much as 50%.

For example, an instrument which is always used in a well lit room may never need a backlight. Using the Lumic software, set the BkLight Mode to 'Off'. With the backlight off, the LED brightness uses the Hi setting and instrument battery consumption is 20 mA. By reducing the Hi LED brightness from 70 to 10 (assuming the brightness is comfortable for the user), the battery consumption drops to 12 mA for a 40% power savings.

## 7.8 Real-time Streaming

Lumic Calibration 2.0 software and this instrument have the ability to stream data from the instrument to a computer. The data can be viewed live inside software or can be recorded on file.

Multiple user-selected parameters can be streamed simultaneously including:

- Remote display of the screen
- All unit values
- Device status
- Live HV current measurement



## SAFETY CONSIDERATIONS

### 8.1 Environmental Conditions for Normal Use

Indoor or outdoor use (While rain resistant, user is cautioned to avoid getting water through detector opening.)

No maximum altitude

Temperature range of -20 to 50 °C (-5 to 122 °F), may be certified for operation from -40 to 65 °C (-40 to 150 °F)

Maximum relative humidity of less than 95% (non-condensing)

Pollution Degree 3 (as defined by IEC 664): (Occurs when conductive pollution or dry nonconductive pollution becomes conductive due to condensation. This is typical of industrial or construction sites.)

Not certified for use in an explosive atmosphere

### 8.2 Warning Markings and Symbols

The Model 3007i Survey meter is marked with the following symbols:



CAUTION (per ISO 3864, No. B.3.1): designates hazardous live voltage and risk of electric shock. During normal use, internal components are hazardous live. This instrument must be isolated or disconnected from the hazardous live voltage before accessing the internal components. This symbol appears on the side panel. Be sure to take the precautions noted in the next section whenever necessary.



The “crossed-out wheeie bin” symbol notifies the consumer that the product is not to be mixed with unsorted municipal waste when discarding. Each material must be separated. The symbol is placed on the label located on the side panel. See section 10, “Recycling,” for further information.



The “CE” mark is used to identify this instrument as being acceptable for use within the European Union.



Caution!

The operator or responsible body is cautioned that the protection provided by the equipment may be impaired if the equipment is used in a manner not specified by Ludlum Measurements, Inc.

### **8.3 Cleaning and Maintenance Precautions**

The Model 3007i may be cleaned externally with a damp cloth, using only water as the wetting agent.

Observe the following precautions when cleaning or performing maintenance on the instrument:

- Turn the instrument OFF and remove the batteries.
- Allow the instrument to sit for one minute before cleaning the exterior or accessing any internal components for maintenance.

## REVISION HISTORY

This section of the manual will be updated with each revision of the Model 3007i in order to document changes over time. Ludlum Measurements' policy is to provide free software upgrades to instruments for the life of the instrument.

**September 2022:** New manual.

**August 2023:** Updated Drawing 519 x 194A. In Chapter 2 Getting Started, under When the Count Timer is Active, added sentence at end of top paragraph on page 29, "If the instrument is only displaying the Count Time, the instrument will alternate between the Count Time and the counts unit which have generated the alarm." Also added note under Figure 2.17 on page 30. Renamed Auxiliary Communications as AuxCOM to simplify tables in Chapter 4 Setup Mode, added AuxCOM PWR Mode and AuxCOM Auto Interval, and in Section 4.6 under AuxCOM Communication Mode, changed descriptions to show values are now reported as text instead of numeric. To avoid confusion, replaced Section 7.5 Instrument Calibration with Hardware Correction in the Advanced Features section of the manual and provided a more detailed description.

**October 2023:** In Chapter 11 Options, added note explaining that only one of three options - Bluetooth, RS-232 Serial Port, and TTL Serial Port - can be configured to each instrument.

**March 2024:** In Chapter 3 Specifications, updated Log in User Controls and Audio and corrected Size and Weight.





## RECYCLING

Ludlum Measurements, Inc. supports the recycling of the electronics products it produces for the purpose of protecting the environment and to comply with all regional, national, and international agencies that promote economically and environmentally sustainable recycling systems. To this end, Ludlum Measurements, Inc. strives to supply the consumer of its goods with information regarding reuse and recycling of the many different types of materials used in its products. With many different agencies – public and private – involved in this pursuit, it becomes evident that a myriad of methods can be used in the process of recycling. Therefore, Ludlum Measurements, Inc. does not suggest one particular method over another, but simply desires to inform its consumers of the range of recyclable materials present in its products, so that the user will have flexibility in following all local and federal laws.

The following types of recyclable materials are present in Ludlum Measurements, Inc. electronics products, and should be recycled separately. The list is not all-inclusive, nor does it suggest that all materials are present in each piece of equipment:

Batteries	Glass	Aluminum and Stainless Steel
Circuit Boards	Plastics	Liquid Crystal Display (LCD)

Ludlum Measurements, Inc. products that have been placed on the market after August 13, 2005, have been labeled with a symbol recognized internationally as the “crossed-out whee-lie bin,” which notifies the consumer that the product is not to be mixed with unsorted municipal waste when discarding. Each material must be separated. On the instrument, the symbol will be placed on the serial number label located on the side of the instrument.

The symbol appears as such:





## OPTIONS

**Lumic Calibration Kit For All Models/All Gens (part # 4519-865):** The kit includes calibration software plus the cables required for calibration. The software allows users to collect data and read, print, and save device parameters. It allows administrators to adjust device parameters.

**Lumic Datalogging Kit (part # 4498-1019):** The kit includes datalogging software plus the required cable. The software allows users to collect data and read, print, and save device parameters. It allows administrators to adjust device datalogging parameters.

**Headphone Option (part # 4498-555):** This provides the Model 3000 series of instruments with a jack and circuitry required for a standard headphone plug. Ludlum Measurements also offers mono/stereo headphones with volume control.

**Shoulder Strap (part # 4498-868):** This adjustable, padded strap comes with a kit to attach it to a Model 3000 series instrument.



Each instrument may only be configured with one of the following three options. The three options listed are not available on all instruments. Contact your sales representative or LMI for details.

**Bluetooth 4.0 LE® (Bluetooth Low Energy, sometimes referred to as Bluetooth Smart) (part # 4519-564):** This feature permits wireless transmission of readings from a connected instrument, allowing operators to remotely monitor the live data on the screen of their mobile device. When paired with Ludlum's Lumic Linker App, the operator can also seamlessly send data to the \*RadResponder Network, which provides a central location for up-to-date information from operators in the field. Reported data includes user, radiometric survey, survey notes, and GPS location, as well as details about the instrument and detector being used. (See the Model 3000 Series Bluetooth LE® Addendum for more details on how to use this option.)

**RS-232 Serial Port (part # 4519-594):** This option adds a true RS-232 serial port connector.

**TTL Serial Port: (part # 4519-595):** This option adds a TTL 3.3 V serial port connector. Available modes are instrument independent. Contact LMI for more information on configura-

tion options.

## STANDARD PARTS LIST

Part Description	Part Number
Model 3007i Neutron Dose Survey Meter	48-4443
Model 3007Bi Neutron Dose Survey Meter	48-4443B
Model 42-49 Detector and Moderator	47-4059
Model 42-49B Detector and Moderator	47-4308
Model 3007/3003 Sphere Assembly	4519-197
Model 3003 Main Board	5519-812
LCD 82 mm x 61.64 mm	7519-186
Unimorph with Harness	8498-542-01
Model 3014 Bezel Assembly	4519-505
Model 3000 Handle Assembly with Datalogging	4498-428
Model 3002 Handle Log Button Keypad	7498-448
Model 3000 Battery Holder Modified	7498-458
Model 3000 USB Cover Assembly Metal Screw	4498-465-01
Lumic and Lumic 2.0 Calibration Software	1370-124

Table 12.1: Standard Parts List



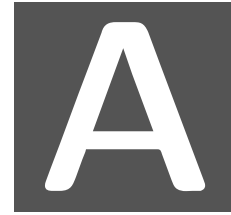

# AUXILIARY COMMUNICATIONS

## A.1 AuxComm Overview

AuxComm, short for Auxiliary Communications, is a feature included on certain Ludlum instruments. An AuxComm port allows the instrument to expand its capabilities with a variety of external devices through a standard serial interface.

## A.2 Requirements

In order to take advantage of the AuxComm functionality, you will need the following:

- A serial or RS-232 serial option
- A wiring harness to connect the target device
- The correct mode set for the AuxComm port

## A.3 Usage

Usage of the AuxComm port is generally very simple from the user's perspective. Most modes initialize everything to be plug-n-play; however, there are a couple of caveats.

If using the SLURM protocol, the user will need to pair the instrument with a mobile device using the hot key listed below.

### A.3.1 AuxComm Usage - Hot Key

There are two types of hot-key presses:

**PIN Generation:** If the UNITS and MODE buttons are both held for longer than 2 seconds (3 beeps), the instrument will present the user with a PIN needed for pairing. Repeat the process to clear the screen.

**Enable:** If the UNITS button is held for longer than 2 seconds (3 beeps), the AuxComm port will toggle on and off each time this is done. The wireless icon will appear when the AuxComm port is enabled.



The pairing PIN is only used for SLURM.

### A.3.2 AuxComm Usage - Pairing

“Pairing” is the process to connect an instrument with a mobile device. It helps verify you are connecting to the correct device, as well as configures the encryption. The pairing process should only be done when both the instrument and mobile device are ready. Ensure the App or software is installed, and then follow these steps:

1. Open connection window in App/Software.
2. Use 2-second PIN hot key to get PIN.
3. Use 2-second PIN hot key to clear screen.
4. Use 2-second Enable hot key to turn on WiFi.
5. Select “Scan” in App/Software.
6. When instrument is found by mobile device, select device in list and then “Pair.”
7. Enter PIN in App/Software from Step 2.



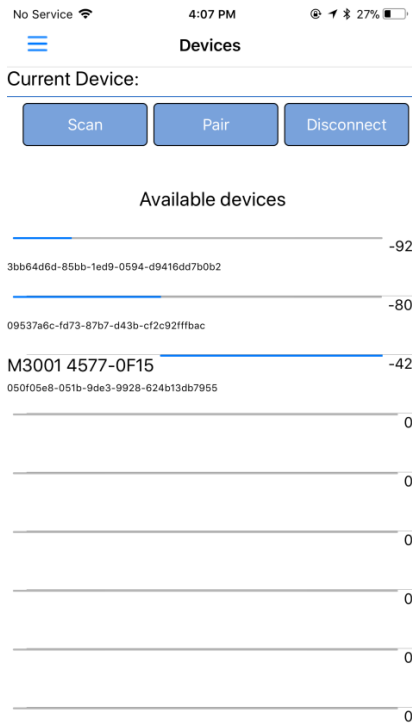

Figure A.1: Example – Device Selection In Lumic Linker App (iOS)

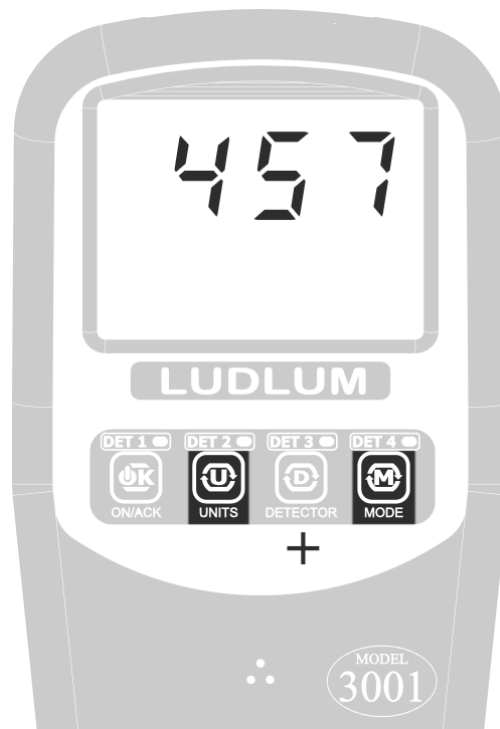

Figure A.2: Example – Pairing

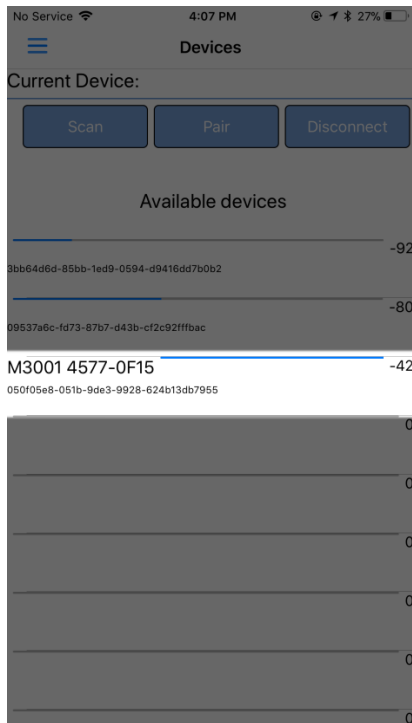

Figure A.3: Example – Model 3000 series Found in Lumic Linker App (iOS)

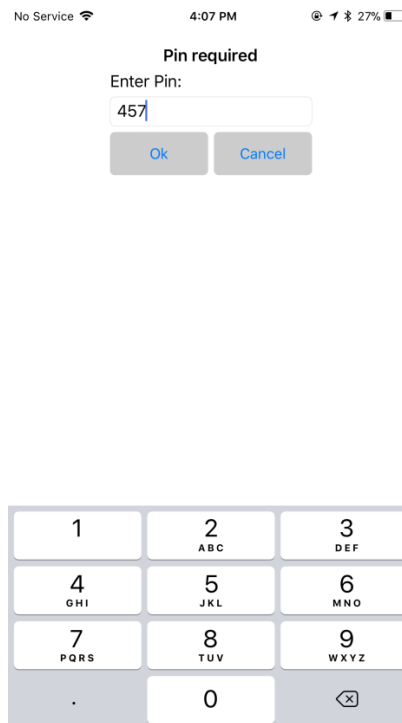

Figure A.4: Example – Entering PIN In Lumic Linker App (iOS)

## A.4 Settings

The settings for AuxComm are only configurable through software. See A.5.

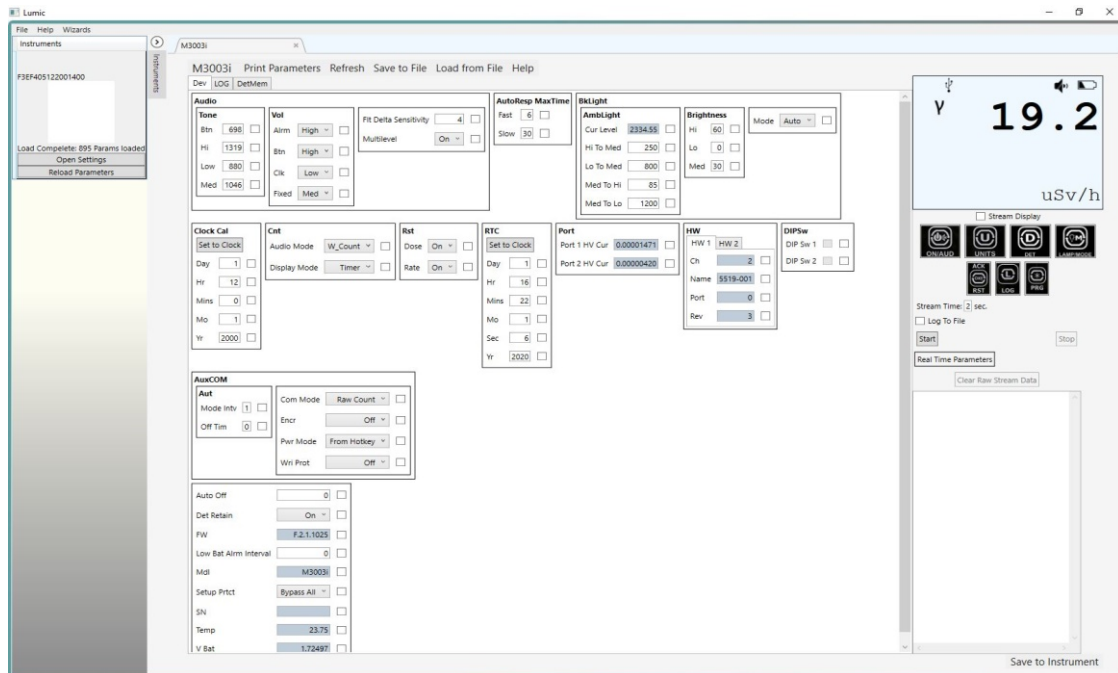

Figure A.5: Example – Lumic 2.0 Calibration Software

### A.4.1 AuxComm Setting - Mode

The mode setting for AuxComm configures how the port will function. The table below lists the modes and their baud rates.

Table A.1: AuxComm Mode

Mode	Baud Rate
SLURM	115200
LMI Direct	115200
Raw Count	115200
CPM	115200
Display	115200

**SLURM:** Used to encapsulate “LMI Direct” messages with encryption and checksums. This mode is primarily used for Bluetooth®.

**LMI Direct:** Full exposure to the “LMI Comm” Communication protocol. This allows reading and writing all parameters, data streaming, etc.

**Raw Count:** Mode that automatically transmits raw, uncorrected counts. The count interval is based on the AuxComm Auto Mode Interval variable (see A.4.6). The output value is the cumulative counts that occurred in the previous interval on all enabled channels.

**CPM:** Mode that automatically transmits the CPM (counts per minute) for the external detector no matter what detector or mode is currently being displayed. The count interval is based on the AuxComm Auto Mode Interval variable (see A.4.6).

**Display:** Mode that automatically transmits the numeric value as well as units prefix, units, and units suffix for the currently displayed screen. The count interval is based on the AuxComm Auto Mode Interval variable (see A.4.6).

### A.4.2 AuxComm Setting - Off Time

This setting defines the number of minutes the AuxComm port will sit idle before turning off. The primary use for this parameter is to save power while using Bluetooth® by turning off the Bluetooth® module if there is no connection. The table below shows valid settings.

Table A.2: AuxComm Auto Off Time

Setting	Description
0	Disabled
1-9	Inactivity minutes before auto off

### A.4.3 AuxComm Setting - Pwr Mode

This setting determines whether or not the AuxComm module is turned on when the instrument is powered on. In addition to power savings, this setting is also intended for use when a user has a need for “radio silence” (no RF broadcasts). This setting does not override the hot key function. Again, the primary use for this parameter is while using Bluetooth®. The table below shows valid settings.

Table A.3: AuxComm Power on at Boot-up

Description
From Hotkey
At Boot

### A.4.4 AuxComm Setting - Write Protect

This setting is an additional security measure that prevents commands that would modify parameters from being executed over the AuxComm port. While using the instrument equipped with a wireless radio, such as the Bluetooth® module, there is the potential for the instrument becoming mis-configured, inadvertently or intentionally, from a remote location. This setting is meant to ensure that cannot happen. The table below shows valid settings.

Table A.4: AuxComm Write Protect

Description
On
Off



If write protect is enabled, it can only be disabled by physically connecting it to the instrument through the USB port.

### A.4.5 AuxComm Setting - Encryption

This setting controls whether or not encryption is enabled on the AuxComm port. While using the instrument equipped with a wireless radio, such as the Bluetooth® module, there is the potential for external eavesdropping or attack from a third party. By utilizing an industry standard encryption, this becomes much more difficult. The table below shows valid settings.



This setting only applies to SLURM mode.

Table A.5: AuxComm Encryption

Description
Off
On



SLURM mode will still require the “pairing” sequence to connect to the instrument.

### A.4.6 AuxComm Setting - Auto Mode Interval

This setting controls the number of seconds for each transmitted value in automatic stream modes. The table below shows valid settings.

Table A.6: AuxComm Auto Mode Interval

Setting	Description
0	As fast as possible (1/4 second on Model 3000 series)
1-255	n-Seconds